

Operating Manual

ZEEnit 700 P

Atomic Absorption Spectrometer



Manufacturer Analytik Jena GmbH
Konrad-Zuse-Str.1
07745 Jena · Germany
Phone + 49 3641 / 77 70
Fax + 49 3641 / 77 92 79
Email info@analytik-jena.com

Service Analytik Jena GmbH
Konrad-Zuse-Str. 1
07745 Jena · Germany
Phone + 49 3641 / 77-7407 (Hotline)
Email service@analytik-jena.com



For a proper and safe use of this product follow the instructions.

Keep the operating manual for future reference.

General information <http://www.analytik-jena.com>

Copyrights and Trade-
marks Microsoft and Windows are registered trademarks of Microsoft Corp.
The identification with ® or TM is omitted in this manual.

Documentation number 150:902.23

Edition B (01/2021)

Implementation of the
Technical Documentation Analytik Jena GmbH

© Copyright 2021, Analytik Jena GmbH

Contents

| | | |
|----------|--|-----------|
| 1 | Basic information | 7 |
| 1.1 | Notes on this user manual | 7 |
| 1.2 | Intended use | 7 |
| 2 | Safety instructions | 9 |
| 2.1 | General notes..... | 9 |
| 2.2 | Safety labeling on the ZEEnit 700 P..... | 9 |
| 2.3 | Requirements for the operating personnel | 11 |
| 2.4 | Safety instructions, transport and installation | 12 |
| 2.5 | Safety instructions for operation..... | 12 |
| 2.5.1 | Safety instructions for electrical equipment..... | 13 |
| 2.5.2 | Hazards associated with the operation of the flame and the graphite furnace..... | 13 |
| 2.5.3 | Safety instructions relating to the formation of ozone and toxic vapors..... | 14 |
| 2.5.4 | Safety instructions for compressed gas cylinders and systems..... | 14 |
| 2.5.5 | Handling of samples, auxiliary and operating materials | 15 |
| 2.5.6 | Decontamination in case of biological contamination | 16 |
| 2.5.7 | Behavior during emergencies..... | 16 |
| 2.6 | Safety instructions: service and repair..... | 17 |
| 3 | Function and setup | 18 |
| 3.1 | Function of the ZEEnit 700 P | 18 |
| 3.1.1 | AAS techniques with the ZEEnit 700 P | 18 |
| 3.1.2 | Optical principle | 19 |
| 3.1.3 | Measurement principle | 21 |
| 3.2 | Electrothermal atomizer with Zeeman magnet..... | 22 |
| 3.2.1 | Background correction principle according to Zeeman..... | 23 |
| 3.2.2 | The Zeeman graphite tube furnace..... | 24 |
| 3.2.3 | The Zeeman magnet..... | 25 |
| 3.2.4 | Gas flows..... | 26 |
| 3.2.5 | Graphite tube variations, furnace parts and inserts | 27 |
| 3.2.6 | Radiation sensor | 28 |
| 3.2.7 | Furnace camera..... | 28 |
| 3.3 | Accessories for the graphite tube technique | 29 |
| 3.3.1 | Autosampler AS-GF..... | 29 |
| 3.3.2 | Mobile cooling unit KM 5..... | 30 |
| 3.3.3 | Solid autosamplers SSA 600 and SSA6 | 30 |
| 3.4 | Flame system | 31 |
| 3.4.1 | Gas automatic | 31 |
| 3.4.2 | Burner-nebulizer system..... | 32 |
| 3.4.3 | Burner and flame type | 33 |
| 3.4.4 | Sensors..... | 34 |
| 3.5 | Accessories for the flame technique..... | 35 |
| 3.5.1 | Automatic samplers AS-F and AS-FD..... | 35 |
| 3.5.2 | Piston compressor..... | 36 |
| 3.5.3 | Injection module SFS 6..... | 36 |
| 3.5.4 | Scraper – automatic burner head cleaner for nitrous oxide flame | 37 |
| 3.6 | Supplementary accessories – Hg/hydride systems..... | 38 |
| 3.7 | Lamp turrets and lamps | 38 |
| 4 | Installation and initial start-up | 40 |
| 4.1 | Installation conditions..... | 40 |
| 4.1.1 | Environmental conditions | 40 |
| 4.1.2 | Energy supply..... | 41 |
| 4.1.3 | Gas supply..... | 42 |
| 4.1.4 | Exhaust unit..... | 43 |
| 4.1.5 | Water cooling..... | 44 |
| 4.1.6 | Space requirement, weight and device layout..... | 44 |

| | | |
|----------|--|-----------|
| 4.2 | Supply and control connections | 47 |
| 4.3 | Removing the transport lock..... | 48 |
| 4.4 | Installing the ZEEEnit 700 P | 49 |
| 4.5 | Installing the mobile cooling unit KM 5 | 49 |
| 4.6 | Installation and start of the ASpect LS program | 50 |
| 4.7 | Mounting the 8-lamp turret and lamp adjustment..... | 50 |
| 4.7.1 | Removing and installing the hollow cathode lamp..... | 51 |
| 4.7.2 | Removing and installing the deuterium hollow cathode lamp..... | 51 |
| 4.7.3 | Setting up the lamp turret in ASpect LS | 52 |
| 4.7.4 | Adjusting the lamps | 54 |
| 4.8 | Graphite tube technique | 56 |
| 4.8.1 | Connections in the sample chamber for the graphite tube technique..... | 56 |
| 4.8.2 | Software settings for the graphite tube technique..... | 56 |
| 4.8.3 | Inserting the graphite tube into the graphite tube furnace..... | 57 |
| 4.8.4 | Formatting the graphite tube | 59 |
| 4.8.5 | Cleaning the graphite tube (clean out) | 60 |
| 4.9 | Autosampler AS-GF..... | 60 |
| 4.9.1 | Completing and installing the autosampler | 60 |
| 4.9.2 | Adjusting the AS-GF..... | 63 |
| 4.9.3 | Populating the sample tray of the AS-GF..... | 64 |
| 4.9.4 | Uninstalling the autosampler AS-GF..... | 64 |
| 4.9.5 | Notes on installing the automatic solid autosampler SSA600 | 65 |
| 4.10 | Flame technique | 65 |
| 4.10.1 | Connections in the sample chamber for the flame technique..... | 65 |
| 4.10.2 | Software settings for the flame technique..... | 66 |
| 4.10.3 | Installation for manual sample supply | 66 |
| 4.10.4 | Installation for continuous working mode / sample supply by autosampler..... | 68 |
| 4.10.5 | Installing the injection module SFS 6..... | 71 |
| 4.10.6 | Installing the scraper at a later stage..... | 72 |
| 4.10.7 | Replacing the burner..... | 73 |
| 4.11 | Starting up the ZEEEnit 700 P with accessories..... | 73 |
| 4.11.1 | Switching on sequence, daily work commencement..... | 73 |
| 4.11.2 | Switching off sequence | 74 |
| 5 | Service and maintenance | 75 |
| 5.1 | Maintenance overview..... | 76 |
| 5.2 | Base device | 77 |
| 5.2.1 | Replacing the fuses | 77 |
| 5.2.2 | Cleaning of sample chambers | 78 |
| 5.3 | Graphite tube furnace | 78 |
| 5.3.1 | Maintaining the graphite tube furnace..... | 78 |
| 5.3.2 | Separation of the graphite tube furnace from the Zeeman magnet and reinsertion | 79 |
| 5.3.3 | Removing and cleaning the temperature sensor group | 82 |
| 5.3.4 | Replacing the upper electrode | 83 |
| 5.3.5 | Replacing the graphite tube jacket and the lower electrode..... | 85 |
| 5.3.6 | Cleaning and changing the graphite tube | 87 |
| 5.4 | Burner-nebulizer system..... | 88 |
| 5.4.1 | Taking the burner-nebulizer system apart..... | 89 |
| 5.4.2 | Cleaning the burner | 91 |
| 5.4.3 | Cleaning the nebulizer | 92 |
| 5.4.4 | Cleaning the mixing chamber | 92 |
| 5.4.5 | Cleaning the siphon | 93 |
| 5.4.6 | Assembling the burner-nebulizer system..... | 93 |
| 5.4.7 | Cleaning the sensor of the burner..... | 94 |
| 5.5 | Autosampler AS-GF..... | 95 |
| 5.5.1 | Washing the dosing tube | 95 |
| 5.5.2 | Servicing the dosing tube..... | 96 |
| 5.5.3 | Replacing the dosing device..... | 98 |
| 5.5.4 | Clean-up after cup overflow..... | 99 |

| | | |
|----------|--|------------|
| 5.6 | Autosampler AS-F, AS-FD | 99 |
| 5.6.1 | Washing the sample paths..... | 99 |
| 5.6.2 | Washing the mixing cup of the AS-FD | 99 |
| 5.6.3 | Replacing the cannulas and guide on the autosampler arm of the AS-FD | 100 |
| 5.6.4 | Replacing the cannula on the autosampler arm of the AS-F..... | 100 |
| 5.6.5 | Replacing the intake tube | 100 |
| 5.6.6 | Replacing the tube set for diluent and washing liquid at the AS-FD..... | 101 |
| 5.6.7 | Clean-up after cup overflow..... | 101 |
| 5.7 | Mobile cooling unit KM 5..... | 101 |
| 5.8 | Compressor | 102 |
| 5.9 | Injection module SFS 6..... | 103 |
| 5.10 | Supply connections..... | 103 |
| 6 | Transport and storage..... | 104 |
| 7 | Waste disposal..... | 105 |
| 8 | Specification | 106 |
| 8.1 | Technical data..... | 106 |
| 8.1.1 | Data for the ZEEnit 700 P | 106 |
| 8.1.2 | Minimum requirements of the ASpect LS software..... | 110 |
| 8.1.3 | Data for the graphite tube technique..... | 111 |
| 8.1.4 | Data for the flame technique | 112 |
| 8.2 | Guidelines and standards..... | 114 |

Figures

| | | |
|---------|--|----|
| Fig. 1 | Warning signs on the front of the ZEEnit 700 P | 10 |
| Fig. 2 | Warning signs on the rear of the ZEEnit 700 P | 11 |
| Fig. 3 | ZEEnit 700 P | 18 |
| Fig. 4 | Optical schematic of the ZEEnit 700 P | 20 |
| Fig. 5 | Principle of transversal inverse Zeeman atomic absorption spectroscopy | 23 |
| Fig. 6 | Zeeman graphite tube furnace | 24 |
| Fig. 7 | Graphite tube furnace, open | 25 |
| Fig. 8 | Inner and outer gas flows in the graphite tube furnace | 26 |
| Fig. 9 | Graphite tube variations | 27 |
| Fig. 10 | Furnace jacket, adapters and inserts | 28 |
| Fig. 11 | Autosampler AS-GF | 29 |
| Fig. 12 | Solid autosampler on the ZEEnit 700 P | 31 |
| Fig. 13 | Nebulizer mixing chamber burner system | 33 |
| Fig. 14 | Burner types | 34 |
| Fig. 15 | Autosampler AS-FD with separate Fluidics module | 36 |
| Fig. 16 | Injection module SFS6 | 37 |
| Fig. 17 | Scraper mounted to 50 mm burner head | 37 |
| Fig. 18 | Setup of the lamp turret | 39 |
| Fig. 19 | Dimensions of the ZEEnit 700 P – front view | 45 |
| Fig. 20 | Dimensions of the ZEEnit 700 P – top view | 46 |
| Fig. 21 | Installation layout of the ZEEnit 700 P | 46 |
| Fig. 22 | Mains switch and bar for supply and control connections | 47 |
| Fig. 23 | Bar for supply and control connections | 47 |
| Fig. 24 | Rear view of the AAS with connections for gas, electricity and water | 48 |
| Fig. 25 | Transport lock on the ZEEnit 700 P | 48 |
| Fig. 26 | Setup of the lamp turret | 51 |
| Fig. 27 | D2HCL holder installed in the lamp chamber | 52 |
| Fig. 28 | D2HCL with the holder removed from the lamp chamber | 52 |
| Fig. 29 | Select lamp/element window | 53 |

| | | |
|---------|--|----|
| Fig. 30 | Lamp turret window | 54 |
| Fig. 31 | Spectrometer window - Energy | 55 |
| Fig. 32 | Elements in the sample chamber for the graphite tube technique | 56 |
| Fig. 33 | Start menu of ASpect LS with settings for the graphite tube | 57 |
| Fig. 34 | Furnace window - Control | 57 |
| Fig. 35 | Graphite tube furnace opened with inserted graphite tube | 58 |
| Fig. 36 | Installing the AS-GF | 61 |
| Fig. 37 | Aligning the AS-GF with the furnace | 62 |
| Fig. 38 | AS-GF adjustment | 63 |
| Fig. 39 | Connections to the burner-nebulizer system in the sample chamber | 65 |
| Fig. 40 | Flame technique, manual sample supply | 66 |
| Fig. 41 | Flame mode, continuous with autosamplers AS-FD and SFS 6 | 68 |
| Fig. 42 | Rear of the autosampler AS-FD | 70 |
| Fig. 43 | Dosing unit at the Fluidics module of the AS-FD | 70 |
| Fig. 44 | SFS 6 installed for manual sample supply to the ZEEnit 700 P | 71 |
| Fig. 45 | Screws on the front burner jaw | 72 |
| Fig. 46 | Fastening rail mounted on burner/knurled screws on the scraper | 73 |
| Fig. 47 | Locking screws for the graphite tube furnace | 79 |
| Fig. 48 | Driven-out furnace, right side | 80 |
| Fig. 49 | Driven-out furnace | 80 |
| Fig. 50 | Driven-out furnace, open, left side | 81 |
| Fig. 51 | Driven-out furnace carrier | 81 |
| Fig. 52 | Furnace partially pressed out of the Zeeman magnet | 82 |
| Fig. 53 | View of the furnace with radiation sensor module from below | 83 |
| Fig. 54 | Furnace tools | 83 |
| Fig. 55 | Electrode, partially pushed out | 84 |
| Fig. 56 | Electrode with insertion device, mounted on the jaw | 85 |
| Fig. 57 | Furnace jacket, partly pressed out | 86 |
| Fig. 58 | Furnace jacket ready for insertion | 86 |
| Fig. 59 | Remove and disassemble the burner-nebulizer system I | 89 |
| Fig. 60 | Remove and disassemble the burner-nebulizer system | 89 |
| Fig. 61 | Withdrawing the nebulizer from the mixing chamber | 90 |
| Fig. 62 | Fittings of the burner | 91 |
| Fig. 63 | Burner, disassembled | 92 |
| Fig. 64 | Spacers inserted in burner jaws | 92 |
| Fig. 65 | Components of the nebulizer | 94 |
| Fig. 66 | Sensor of the burner | 95 |
| Fig. 67 | Window "Autosampler/Function tests" | 96 |
| Fig. 68 | Dosing tube at the AS-GF | 96 |
| Fig. 69 | Dosing unit at AS-GF and AS-FD | 98 |

Tables

| | | |
|---------|--|----|
| Table 1 | Use and sample volume of different graphite tube variations | 27 |
| Table 2 | Furnace parts and inserts | 28 |
| Table 3 | Gases in the graphite tube technique | 42 |
| Table 4 | Gases – flame technique | 43 |
| Table 5 | Exhaust unit requirements | 43 |
| Table 6 | Water cooling | 44 |
| Table 7 | Measurements and weights of the components of the ZEEnit 700 P | 45 |
| Table 8 | Maintenance overview | 76 |
| Table 9 | Fuses on the rear | 77 |

1 Basic information

1.1 Notes on this user manual

The ZEEnit 700 P is intended for operation by qualified specialist personnel observing this user manual.

This user manual is addressed to personnel familiar with analysis and provides information about the design and function of the ZEEnit 700 P and the necessary know-how for the safe handling of the device and its components. Furthermore, the user manual includes information on the maintenance and servicing of the device as well as hints on potential causes for malfunctions and their correction.

Conventions

Instructions for actions which occur in chronological order are numbered and combined in action units.

Warnings are marked by a warning triangle and a signal word. The type, source and consequences of the danger are stated together with notes on preventing the danger.

The elements of the **control and analysis program** are indicated as follows:

- Terms used in the program are identified with **SMALL CAPS** (e.g., Menu FILE).
- Buttons are identified by square brackets (e.g., [OK] button)
- Menu items are separated by arrows (e.g. FILE ▶ OPEN)

Symbols and signal words

The user manual uses the following symbols and signal words to indicate hazards or instructions. The safety instructions are always placed before an action.



WARNING

Indicates a potentially hazardous situation which might cause fatal or very serious injuries (deformations).



CAUTION

Indicates a potentially hazardous situation which might cause minor or moderate injuries.



NOTICE

Indicates potential damage to equipment or the environment.

1.2 Intended use

The atomic absorption spectrometer ZEEnit 700 P is a compact tandem spectrometer with a transversely heated graphite tube atomizer with Zeeman background correction at the furnace as well as a flame atomizer with deuterium background correction. The Zeeman graphite tube furnace and flame module are arranged in two separate sample chambers, the associated autosamplers are hung in the sample chamber walls.

With the ZEE nit 700 P, measurements using the graphite tube and flame techniques can be made in sequence without switching over. For the hydride technique and the HydrEA technique as coupling with the graphite tube furnace, there are hydride systems available as accessories for batch and continuous operation. The graphite tube furnace has an opening on the side for solid samples next to the pipette opening for liquid samples and, together with the manual or automatic solid autosampler, is designed for direct solid analysis.

2 Safety instructions

2.1 General notes

For your own safety and to ensure error-free and safe operation of the ZEEnit 700 P, please read this chapter carefully before using the appliance.

Observe all safety notes listed in this user manual and all messages and notes displayed by the control and analysis program ASpect LS on the monitor.

Besides the safety instructions in this user manual and the local safety regulations that apply to the operation of the device, the general applicable regulations regarding accident prevention, occupational health and safety and environmental protection have to be observed and complied with.

References to potential dangers do not replace the work protection regulations which must be observed.

2.2 Safety labeling on the ZEEnit 700 P

Damaged or missing warnings and information symbols can cause incorrect actions leading to personal injury or material damage! Labels containing symbols must not be removed or moistened with methanol! Damaged symbol labels must be replaced without delay!

Observe the warning signs on the device! The following warning signs are displayed on the ZEEnit 700 P:



Fig. 1 Warning signs on the front of the ZEEnit 700 P

- 1 Warning sign on the inside of the door to the lamp chamber
- 2 Warning sign in the sample chamber of the graphite tube furnace
- 3 Warning sign in the flame sample chamber

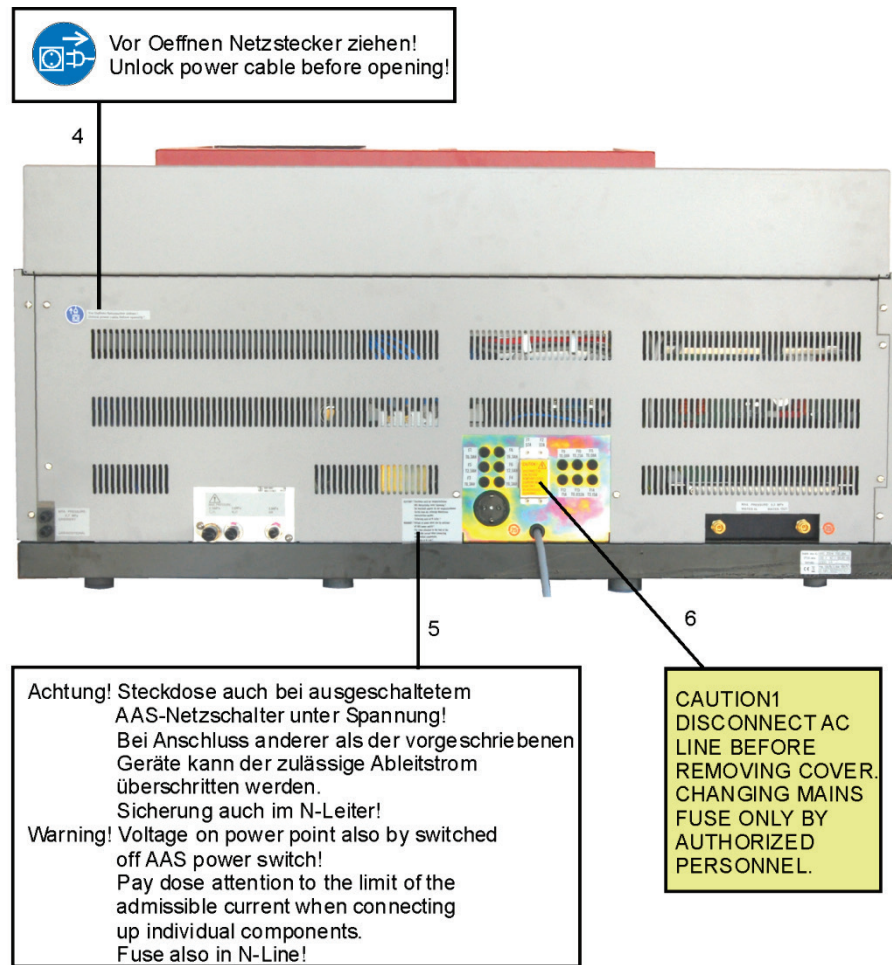

Fig. 2 Warning signs on the rear of the ZEEnit 700 P

- 4 Warning sign on the rear of the ZEEnit 700 P
- 5 Warning sign next to the connection socket
- 6 Warning sign on the mains fuse cover

2.3 Requirements for the operating personnel

The ZEEnit 700 P must only be operated by qualified specialist personnel instructed in the use of the device. The instruction must also include conveying the content of this user manual and the user manuals of other system components.

In addition to the safety at work instructions in this user manual the generally applicable safety and accident prevention regulations of the respective country of operation must be observed and adhered to. The operator must ascertain the latest version of these regulations.

The user manual must be accessible to the operating and service personnel at any time!

2.4 Safety instructions, transport and installation

Observe the following notes:

- The ZEEnit 700 P is always installed by the service department of Analytik Jena or by specialist personnel that was authorized and trained by Analytik Jena. Independent assembly and installation are not permitted. Incorrect installation can create serious hazards.
- The ZEEnit 700 P weighs 225 kg. Use a lift truck to transport the device.
- Four people are required to move the device in the laboratory by holding the device on four firmly screwed-in carrying handles.
- Perform a professional and documented decontamination of the device before returning it to Analytik Jena. The decontamination protocol is provided by the service when the return is registered. Analytik Jena must refuse acceptance of contaminated devices. The sender may be liable for any damage caused by inadequate decontamination of the device.

Protection against explosion and fire

- The ZEEnit 700 P must not be operated in an explosive environment.
- Smoking and open flames in the operating room of the AAS are prohibited!
- The operator is responsible for establishing a control method to ensure that the N₂O and acetylene connectors are leak-tight.

2.5 Safety instructions for operation

- Prior to starting up the device, the operator of the ZEEnit 700 P must verify the proper condition of the device including the condition of its safety equipment. This applies in particular after each modification or extension of the device or its repair.
- The device must only be operated if all protective equipment (e.g. covers and doors) are in place, properly installed and fully operational. The sound condition of the protection and safety equipment must be checked regularly. Any defects must be corrected as soon as they occur. Protective and safety equipment must never be removed, modified or switched off during operation.
- Modifications, conversions and extensions to the device are only permitted after consultation with Analytik Jena. Unauthorized modifications can jeopardize the device's operational safety and may lead to limitations regarding the warranty and access to customer service.
- During operation, the operator must have free access to all connections and the power switch on the right side of the device as well as to the power strip.
- The ventilation equipment on the device must be in good working condition. Covered ventilation grilles or slits etc. may cause the device to break down or damage the device. When placing the device and system components observe a minimum clearance of 150 mm to walls and neighboring installations.
- Prevent any liquids from entering the inside of the instrument. The liquids might get into contact with electronic components and cause a short circuit.

2.5.1 Safety instructions for electrical equipment

Work on the electrical components of the ZEEnit 700 P may only be performed by a qualified electrical technician according to applicable electro-technical regulations. Lethal voltages may occur in the device! Contact with live components may cause death, serious injury or painful electrical shock.

Observe the following notes:

- The mains plug must be connected to a proper CEE power socket to ensure that the device meets protection class I (ground connector). The device may only be connected to power sources whose nominal voltage is the same as that on the type plate of the equipment. The protective effect must not be invalidated by the use of an extension line which does not have a protective conductor.
- The ZEEnit 700 P and its system components must always be switched off before being connected with one another.
- The auxiliary components that are to communicate with each other, for example PC, monitor, printer and hydride system, have to be connected to the power strip that is supplied with the device. The compressor needs a separate power supply. When connecting own components to the power strip, observe the maximum allowable drain current.
- Before opening the device it must be switched off on the device switch and the mains connector must be disconnected from the mains outlet!
- The ZEEnit 700 P must be switched off before carrying out any electrical work and the **mains plug must be pulled out**. Safe disconnection from the mains can only be achieved by pulling out the mains plug. **The power strip is still energized, even when the ZEEnit 700 P is switched off at the mains switch on the right side wall.** The power strip socket to which the ZEEnit 700 P is connected is **protected by a fuse in both wires**, one in the L conductor (line) and one in the N conductor (neutral). This can mean in the case of a fault that connected components are supplied with voltage via the L-line, but no current can flow through the N-line, i.e., without a more thorough check, the connected devices appear to be voltage-free, which is not true.
- Any work on the electronics (behind the device enclosure) may only be carried out by the customer service of Analytik Jena and specially authorized technicians.

2.5.2 Hazards associated with the operation of the flame and the graphite furnace

- HCL, D₂-HCL, the heated graphite tube (T > 1000 °C) and the flame of the burner transmit optical radiation (in the UV range and the visible range). Do not look into the rays emitted by the lamp, the graphite tube or the flame without UV protection goggles. Protect the skin against UV radiation.

Switch off the lamp by means of the control and analysis software ASpect LS before opening the lamp door: Set the lamp current in [mA] to zero in the OPTICAL PARAMETERS section of the SPECTROMETER / CONTROL window. Open the drop-down list BACKGROUND CORRECTION and select the option NO BACKGROUND. Click [CONFIGURE]. Negate the error message.

To observe the placement of the samples or the drying of liquid samples, the dental mirror may only be inserted into the beam path from the left side of the graphite furnace. When observing on the right side of the furnace, UV radiation may be reflected.

- The sample chamber door (safety glass pane) must be closed and the flame supervised when it is burning. Ensure that the flame detector is working correctly.
- For devices with hydride technique, only work with the sample chamber door (safety glass pane) closed.
- The fuel gas pressure must not fall below 70 kPa to prevent the flame from firing back. The integrated pressure sensor will automatically switch off the ZEEnit 700 P if this condition is not met. In addition to that, monitor the pressure on the pressure gage of the gas supply.
- Electromagnetic dispersion fields with flux densities of $\leq 100 \mu\text{T}$ occur in the vicinity of the sample chamber due to the unipolar Zeeman magnetic field with maximum flux densities between 0.5 and 1.0 Tesla and also due to the heating of the graphite tube.
When operating the ZEEnit 700 P, people with pace makers are not permitted in close range.
- When using graphite furnace technique, do not look into the graphite furnace opening without wearing protective goggles. Sputtering sample substances and hot graphite particles may cause eye and face injuries.
- High temperatures occur during flame and graphite furnace operation. Do not touch hot parts such as the burner head or the graphite furnace during or immediately after a measurement. Observe the required cooling times.
- Do not wear any metallic jewelry (especially around the neck) when working with the ZEEnit 700 P. Not observing this instruction may cause a short circuit in the electrically heated furnace. In case of a short circuit, the jewelry may become very hot and cause burns.
- In Zeeman operation with magnetic field strengths of 1.0 Tesla, the sound level can be as high as 75 dBA. If the nitrous-oxide-acetylene flame blows back into the mixing chamber, the momentary sound level lies below 130 dBA.

2.5.3 Safety instructions relating to the formation of ozone and toxic vapors

The UV radiation of the hollow cathode lamps (HCL, D₂-HCL) and the N₂O/acetylene flame causes an interaction with the surrounding air to form toxic concentrations of ozone exceeding the permissible limit. Furthermore, toxic byproducts may escape from the samples or while the samples are processed.

Observe the following note:

- The ZEEnit 700 P may only be operated when the exhaust unit is activated.
- Always keep the sample chamber closed when the flame is lit.

2.5.4 Safety instructions for compressed gas cylinders and systems

Observe the following notes:

- The operating gases (argon, acetylene and nitrous oxide) are taken from compressed gas containers or local compressed gas systems. The required purity of the gases must be ensured.
- Pure oxygen or oxygen-enriched air must not be used as an oxidant when using flame technique. There is a risk of explosion.

- Work on compressed gas cylinders and systems must only be carried out by individuals with specialist knowledge and experience in compressed gas systems.
- The safety instructions and guidelines for operating compressed gas cylinders or compressed gas systems that apply at the operating location must be strictly complied with.
- Compressed air hoses and pressure reducers may only be used for the assigned gases.
- Incoming piping, screwed joints and pressure reducers for nitrous oxide (N₂O) must be kept free of grease.
- Pay particular attention to escaping acetylene! Combined with air, acetylene forms highly flammable mixtures. The gas can be identified by its distinct garlic-like odor.
- Operate the acetylene cylinder only in an upright position and secured against falling over. When the cylinder pressure is lower than 100 kPa, the acetylene cylinder must be replaced to avoid acetone entering the automatic gas control.
- The operator must carry out weekly safety checks regarding the status and for leaks on all gas supplies and connectors including the ones on the device itself. Possible pressure losses from closed systems and lines under pressure are to be determined. Leaks and damaged must be repaired without delay.
- The gas supply must be closed prior to inspections, service and repairs!
- After successful repair and service of the components of the compressed air cylinders or system the device must be checked for sound operation prior to recommissioning!
- Unauthorized assembly and installation are not permitted!
- After changing the gas cylinder, thoroughly ventilate the cylinder location.

2.5.5 Handling of samples, auxiliary and operating materials

The operator is responsible for the selection of substances used in the process as well as for their safe handling. This is particularly important for radioactive, infectious, poisonous, corrosive, combustible, explosive and otherwise dangerous substances.

Observe the following notes:

- When handling dangerous substances local safety codes and guidelines must be observed.
- Warnings on the labels must always be observed. Only use labeled tubes. Use suitable body protection (laboratory coat, safety goggles and rubber gloves) when handling samples.
- The ZEEnit 700 P must only be operated under an activated laboratory exhaust hood (hazards arising from the formation of ozone, combustion gases produced by the samples, poisonous and combustible by-products from sample preparation processes).
- Keep flammable and explosive substances away from the flame.
- Cleaning with hydrofluoric acid must be carried out in an exhaust chamber. The operator must wear a rubber apron, gloves and a face mask when handling hydrofluoric acid.

- Sodium borohydride (NaBH₄) is highly corrosive, hygroscopic and, in solution, extremely aggressive. Avoid dripping and spilling of reduction agent.
- Biological samples must be handled according to local guidelines regarding the handling of infectious material.
- When measuring material containing cyanide you have to make sure that prussic acid cannot be generated in the waste bottle, i.e. the waste solution must not be acidic.
- Ensure that all residue liquid from the nebulizer and the automatic sampler is directed into the waste bottle supplied.
- The operator is responsible for ensuring that waste materials such as drained coolant and residue liquid from the waste bottle are disposed of in an environmentally responsible manner and according to local regulations.

Examples of organic solvents

| | |
|-------------------------------|--|
| Methyl isobutyl ketone (MIBK) | Flammable, highly volatile, noxious-smelling |
| Toluene | Flammable, hazardous to health |
| Kerosene | Flammable, hazardous to the aquatic environment, hazardous to health |
| Methanol, ethanol, propanol | Flammable, partly acutely toxic |
| Tetrahydrofuran (THF) | flammable, hazardous to health, extremely volatile, dissolves polyethylene and polystyrene |

This list is not exhaustive. Other solvents could be considered when using the ZEEnit 700 P. If in doubt about the potential hazards ask the manufacturer to provide more detailed information.

2.5.6 Decontamination in case of biological contamination

Observe the following notes:

- The operator is responsible for carrying out suitable decontamination should the device be contaminated externally or internally with dangerous substances.
- Spots, drops or larger spillages should be removed and cleaned using an absorbent material such as cotton wool, laboratory wipes or cellulose.
Wipe the affected area with a suitable disinfectant such as Incidin Plus solution.
Then, wipe the cleaned areas dry.
- Before using a cleaning or decontamination procedure other than that prescribed by the manufacturer, the user is required to check with the manufacturer that the intended procedure will not damage the device. Safety labels attached to the ZEEnit 700 P must not be moistened with methanol.

2.5.7 Behavior during emergencies

Observe the following notes:

- If there is no immediate risk of injury, in hazardous situations or in case of accidents, immediately switch off the ZEEnit 700 P using the mains contactor on the right side wall of the device. Disconnect the mains plug from the mains socket.
- Make sure that the mains plug is readily accessible.

- Switch off the installed components using the mains switch of the connected power strip. Ensure that the positioning of the power strip allows quick access.
Caution! For the PC there is a risk of data loss and damage to the operating system!
- Close the gas supply immediately after switching off the devices, if possible.

2.6 Safety instructions: service and repair

Observe the following notes:

- The ZEEnit 700 P is unpacked and assembled by the customer service department of Analytik Jena or its authorized and trained personnel. Unauthorized servicing can lead to maladjustment and damage of the device. Therefore, the operator is only allowed to carry out the maintenance tasks listed in chapter "Service and maintenance" on page 75.
- The exterior of the ZEEnit 700 P must only be cleaned with a damp – not dripping – cloth. Use only water and, if required, customary surfactants.
- For cleaning the sample compartments and transport channels (tube system) of the ZEEnit 700 P the operator is required to establish appropriate safety precautions – particularly in terms of contaminated and infectious materials.
- If water or other liquids are found to leak out of the instrument, contact the Analytik Jena service engineers.
- Use only original spare parts, wear parts and consumables. They have been tested and ensure safe operation. Glass parts are wear parts and are not subject to the warranty.

3 Function and setup

3.1 Function of the ZEEnit 700 P

3.1.1 AAS techniques with the ZEEnit 700 P

The ZEEnit 700 P as a compact device with 2 separate sample chambers includes, in combination with appropriate autosamplers and accessories, all important atomization techniques:

- Graphite tube technique for liquid samples.
- Graphite tube technique for solid samples.
- Flame technique stationary and as injection technique.
- Hydride and mercury cold vapor technique.
- HydrEA technique as coupling between hydride and graphite tube techniques.

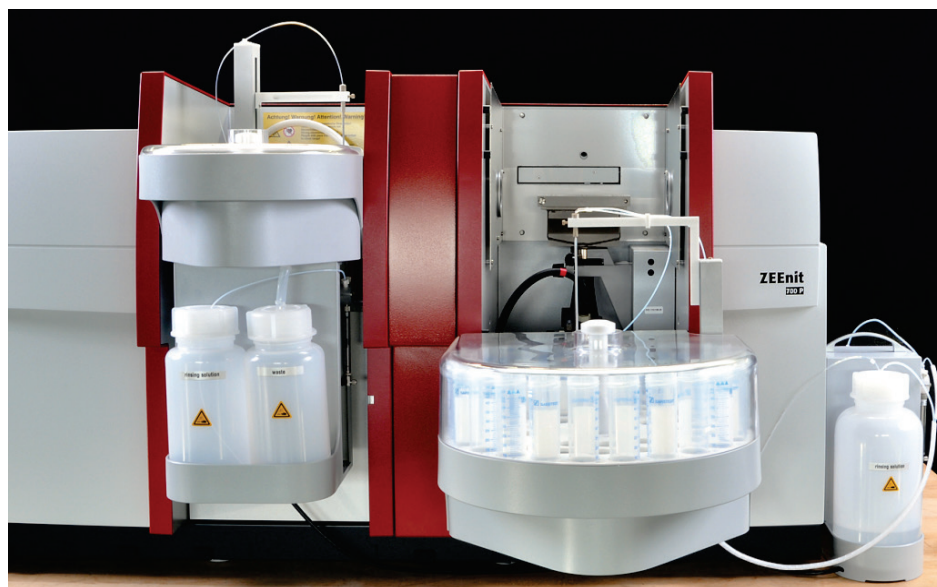

Fig. 3 ZEEnit 700 P

The core piece for the graphite tube mode is a transversely heated graphite tube furnace set up in the vertical position with transversal magnetic field according to the inverse Zeeman principle. The graphite tube furnace is, with its additional horizontal sample insertion opening on the left side in combination with the manual solids autosampler SSA 6 or the automatic solid sampler SSA 600, suitable for direct solids analysis. With this, the time-consuming and contamination-susceptible sample information (the main source of error in solution analysis) is eliminated.

For the flame mode the ZEEnit 700 P is designed as a 2-beam device and can be used in single-beam mode. The core piece for the flame mode is the mixing chamber-nebulizer system with direction-independent stable nebulizer.

For the flame injection technique, the time-programmed injection switch SFS 6 is available that couples the sample segments by means of valve switchover into a constant carrier-free stream.

Hydride and HydrEA technique with the hydride systems of the new generation (HS 50, HS 55 modular, HS 60 modular) are the preferred processes for the detection-sensitive determination of the hydride-forming elements As, Bi, Sb, Se, Sn, Te and of Hg. The HydrEA technique (hydride technique with electrothermal atomization) is based on the fact that the metal hydride or mercury vapor is enriched on the iridium-coated, preheated graphite tube and is atomized at 2100 °C or 800 °C respectively.

3.1.2 Optical principle

The ZEEnit 700 P is a 2-beam device that can be used either as a single-beam or double-beam device depending on the technique. On the left side the 8-lamp turret (11 in Fig. 4) is vertically arranged. The lamp turret accepts 1.5" hollow cathode lamps (HCL) as the primary radiation source. On the left side there is in addition a deuterium hollow cathode lamp (D2HCL) (2 in Fig. 4) for classical background compensation.

An optical beam splitter (1 in Fig. 4) with reflection and transmission fields in checkerboard pattern unites the radiation of the active primary HCL with the continuum radiation of the D2HCL and splits it simultaneously into the sample and reference beams. Identical beam paths with the same beam distribution and density in the spatial angle used for both radiation sources make a background compensation up to an absorbance of 2.0 possible with the D2HCL.

The sample beam passes both sample chambers in turn and is offset 40 mm downwards by the two mirrors (9 in Fig. 4) between the sample chambers. The reference beam is led behind both sample chambers. A rotating sector mirror (6 in Fig. 4) with 90° reflection and transmission sectors brings the sample and reference beams together.

For the graphite tube technique with Zeeman background correction, the ZEEnit 700 P works as a single-beam device without D2HCL, but with a movable crystal polarizer (7 in Fig. 4) in the sample radiation beam. The movable beam splitter for the HCL radiation is also moved to the 100 % reflection position at the same time. The Zeeman-graphite tube furnace delivers radiation components with vertical and horizontal alignments. The crystal polarizer allows all radiation components with vertical alignment to pass without deflection, the radiation components with horizontal alignment are deflected so far that they fall completely on the slit mask next to the inlet slit even with the large slit width (0.6 mm). In all other techniques the crystal polarizer is located outside the radiation beam.

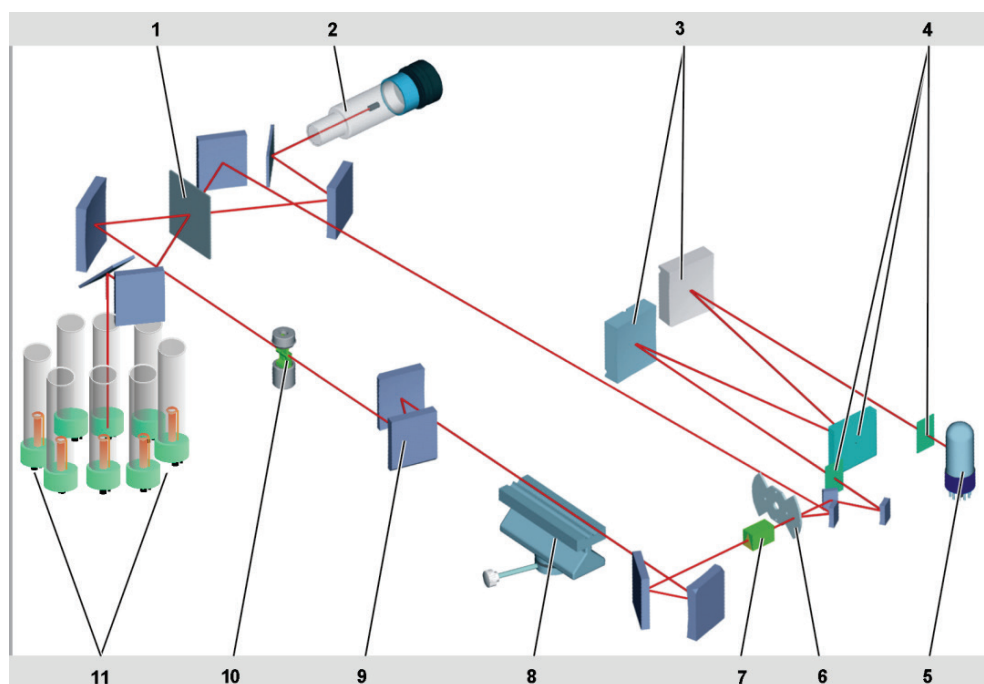

Fig. 4 Optical schematic of the ZEEnit 700 P

- | | |
|---|--|
| 1 Beam splitter mirror | 7 Crystal polarizer |
| 2 Deuterium hollow cathode lamp (D2HCL) | 8 Burner in the flame sample chamber |
| 3 Monochromator mirror | 9 Mirrors between the sample chambers |
| 4 Entrance slit, grid, exit slit | 10 Electrodes with graphite tube in the furnace sample chamber |
| 5 Photomultiplier | 11 Lamp turret with 8 hollow cathode lamps |
| 6 Sector mirror | |

The sample beam or united sample/reference beam is projected onto the entrance slit of a grid monochromator (3 and 4 in Fig. 4), that is fitted with the fixed bandwidth of 0.2 nm / 0.5 nm / 0.8 nm / 1.2 nm. The monochromator selects the resonance wavelengths assigned to the element. The wavelength setting of the monochromator takes place according to the theoretical step number, referred to the Pb-line 405.8 nm as the initialization point and corrected by an amount which results from the device-specific wavelength interpolated function which is available as a polygon curve. 9 interpolation points are distributed equally over the wavelength range from the 0. order up to 900 nm.

A peak-pick program is used to find the maximum of the particular line. The wavelength setting takes place using a wavelength drive driven by a step motor with a resolution of 0.005 nm per step.

A photomultiplier (5 in Fig. 4) at the exit of the monochromator measures, synchronously with the clocking of the light sources, the intensity of the impinging radiation.

3.1.3 Measurement principle

| | |
|---|---|
| Graphite tube technique with Zeeman background correction | <p>The element-specific absorption of the radiation of a hollow cathode lamp is measured by atoms in the base state. In this, the absorption signal is a measure for the concentration of the relevant element in the analyzed sample. The HCL delivers a line spectrum from which a suitable resonance line is decoupled by the monochromator.</p> <p>A unipolar, horizontal alternating magnetic field with a frequency of 200 Hz is applied to the graphite tube furnace. In the alternating field, the absorption levels of the analyte atoms of the current analysis line are split up into the horizontally polarized σ components σ^+, σ^- and the vertically polarized π components. The downstream crystal polarizer allows all radiation components with vertical alignment to pass without deflection, the radiation components with horizontal alignment are sufficiently deflected that they do not impinge on the entrance slit. In both measurement phases "Magnetic field on" and "Magnetic field off", only the parts vertical to the magnetic field, i.e., only the vertically polarized parts of the HCL radiation, are considered. Half of the HCL radiation intensity is forfeited:</p> <ul style="list-style-type: none"> ▪ In the measurement phase "Magnetic field on": the σ^+, σ^- components. ▪ In the measurement phase "Magnetic field off": half of the total radiation of the HCL polarized in all directions. |
| All other techniques with deuterium background correction | <p>In the measurement phase "Magnetic field off", the unaffected absorption signal is present; the spectrometer measures the sum of the specific and nonspecific absorption. In the measurement phase "Magnetic field on", only the π components are recorded. It experiences, however, no element-specific absorption; only the weakening from the molecules and particles that show no Zeeman effect in the magnetic field. The non-specific absorption (background) is measured directly on the analysis line.</p> <p>The difference between the signals of both measurement phases provides the element-specific absorption.</p> <p>For both signals, the radiation source, the radiation beam, the measurement wavelength, polarization and reception channel are identical, i.e., a genuine double-beam effect is achieved using one beam (here the single-beam device). The quasi double-beam arrangement delivers an extremely good base line stability.</p> <p>The continuum radiation of a D2HCL is used for compensation of the background absorption. The radiation of the line radiator (primary HCL) with its extremely narrow base line (resonance line) is element-specific and weakened non-specifically by scattering. In doing this, the total radiation is recorded. The radiation of the D2HCL is mainly weakened by the broad band, element-nonspecific absorption, the minimum element-specific part can be neglected. The formation of the difference between the two signals gives the element-specific absorption.</p> <p>The intensities of both radiation sources are automatically checked and adjusted if necessary.</p> |

3.2 Electrothermal atomizer with Zeeman magnet

The graphite tube furnace (electrothermal atomizer, EA) is the core piece for working in EA mode and the HydrEA technique.

Graphite tube furnace characteristics

- Constant temperature ratios along the entire tube length ensured by the design of the transverse-heated graphite tube.
- Realization of linear temperature-time runs according to a sensorless control model on the basis of saved thermoelectrical parameters and an adaptive control.
- Protective gas flows, independent of each other and symmetrical to the furnace center, which ensure effective graphite tube and furnace window cleaning, and which also ensure fast and safe transport of the thermally disintegrated products of the sample for disposal.
- Low consumption of protective gas, at the same time ensuring effective protection against interference with atmospheric oxygen.

The analytical advantage of the graphite tube technique in conjunction with the background compensator is the problem-free trace and ultra-trace analysis of real samples with a complex matrix.

In the analysis, each sample runs through a furnace program (temperature-time program) with the aim of drying wet samples and of separating out any distorting incidental substances before atomization.

The furnace program runs in four basic steps:

- Drying the sample.
- Thermal pretreatment, separating (ashing or pyrolysis of) distorting sample incidental substances (matrix).
- Atomizing the sample.
- Cleaning the graphite tube and preparing for the next measurement.

The operator optimizes these basic steps for each analysis problem with the ASpect LS control software.

3.2.1 Background correction principle according to Zeeman

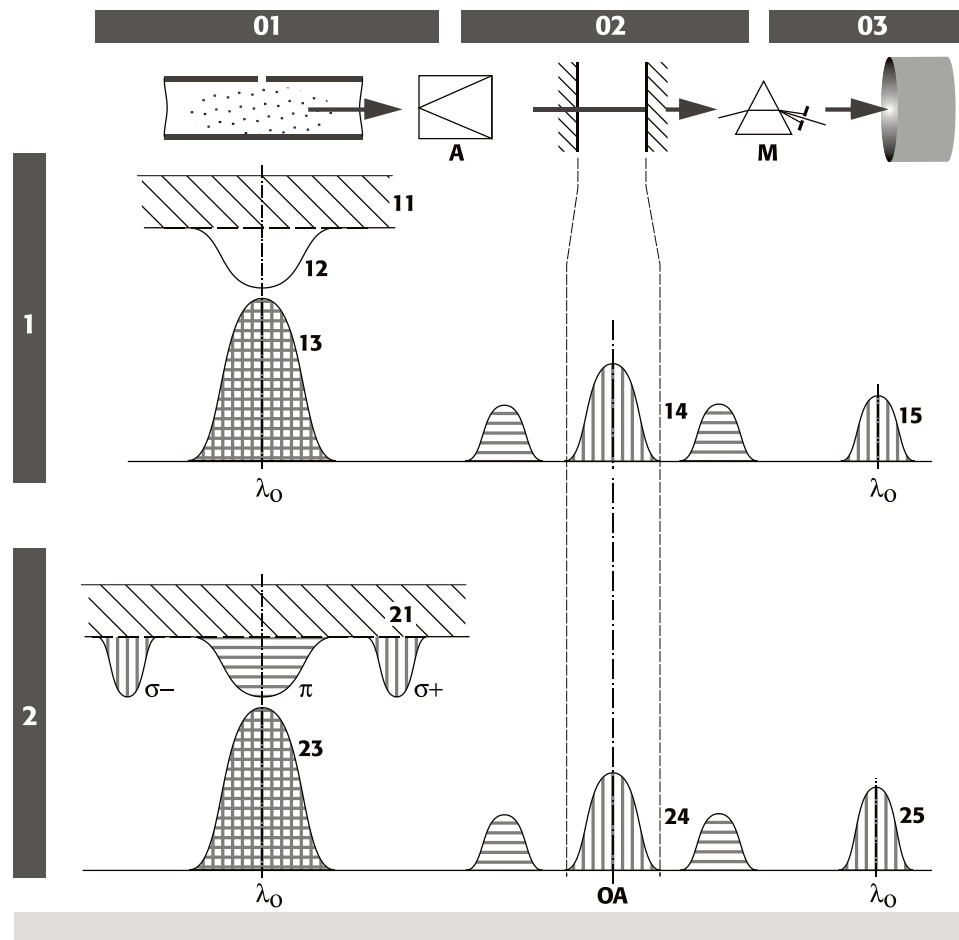

Fig. 5 Principle of transversal inverse Zeeman atomic absorption spectroscopy

| | |
|--|--|
| 01 Atomizer | A Polarizer-analyzer |
| 02 Entrance slit | M Monochromator |
| 03 SEV | OA Optical axis |
| 1 Phase 1 – Measuring the total absorption | 2 Phase 2 – Measuring background absorption |
| 11 Background, no polarization | 21 Background, no polarization |
| 12 Analyte, no polarization | σ^- , π , σ^+ Analyte, split by the magnetic field with respect to wavelength and polarization direction |
| 13 HCL emission, all polarization directions | 23 HCL emission, all polarization directions |
| 14 Radiation at the entrance slit, spatially separated by the polarizer-analyzer | 24 Radiation at the entrance slit, spatially separated by the polarizer-analyzer |
| 15 Only vertically polarized light, weakened by analyte and background | 25 Only vertically polarized light, weakened by background |

Inverse and transverse Zeeman effect

The Zeeman effect refers to the splitting of energy levels of electrons and thus the absorption levels under the influence of a strong magnetic field. If the magnetic field affects the atomic cloud of the sample in the atomizer (graphite tube furnace), this is an inverse Zeeman Effect. A transverse Zeeman layout exists if the optical measurement beam (the observation) is arranged vertical to the magnetic field.

With a normal Zeeman effect, the absorption levels of the analyte atoms exposed to the magnetic field are split in a non-wavelength-shifted π component and two wavelength-shifted σ components σ^+ , σ^- .

With an abnormal Zeeman effect, more than one non-wavelength-shifted π component and more than two wavelength-shifted σ component occurs.

The π and the σ components absorb different portions of the total HCL radiation that differ in terms of the direction of polarization:

- The absorption capacity of the π component lies in the direction of the magnetic field vertical to the radiation direction in the meridional level (horizontal).
- The absorption capacity of the σ components (σ^+ , σ^-) lies vertical to the magnetic field and to the radiation direction in the sagittal level (vertical).

The σ components have half the intensity of the π component and are shifted by an equal amount to the higher and lower wavelengths from the original wavelength.

3.2.2 The Zeeman graphite tube furnace

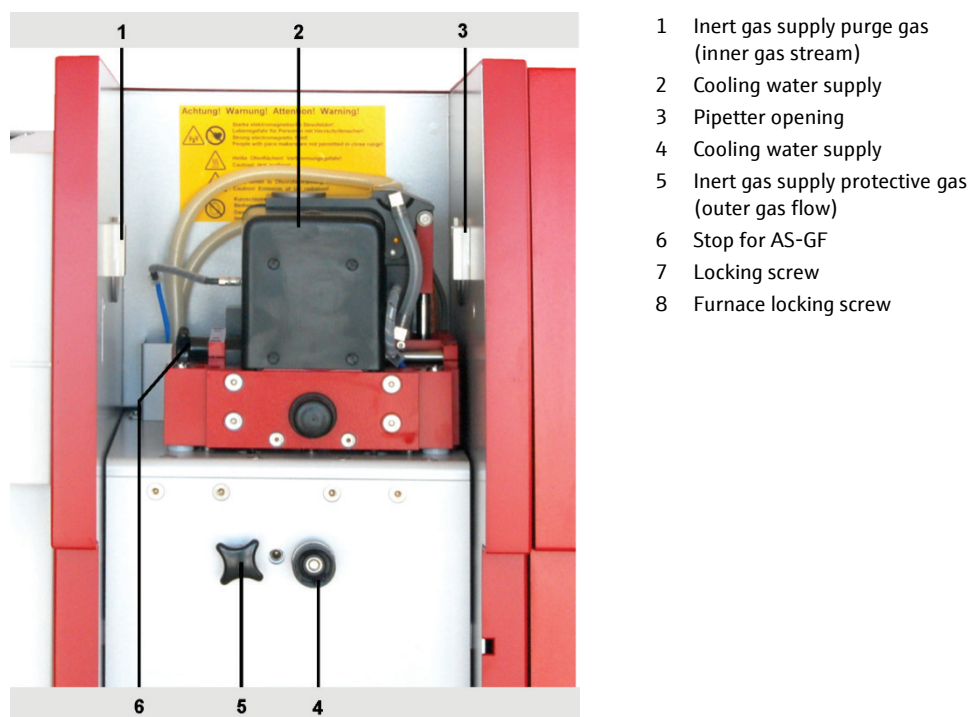

Fig. 6 Zeeman graphite tube furnace

The furnace consists of a fixed and a movable furnace part. Both furnace parts are water-cooled metal bodies, in which the ring-shaped graphite electrodes are to be found. The transversely heated graphite tube is pneumatically pushed against the graphite electrodes via its contact surfaces. There is another graphite component located between the metal bodies that supports the electrodes, the furnace jacket. Together with the graphite electrodes it forms an enclosure around the graphite tube, which stabilizes the thermal radiation conditions of the graphite tube and also guarantees chemically inert conditions. When the movable furnace part is closed, the tube is pressed into the contacts, without coming into contact with the furnace jacket.

The graphite tube is hermetically sealed in a protective gas atmosphere by the two graphite electrodes and the furnace jacket. The furnace jacket is formed in a way to allow for beam passage, furnace windows and protective gas supply as well as guides for automatic alignment of the graphite tube when closing the furnace.

The upper horizontal metal block can be swiveled away to the right by a pneumatic cylinder. The lower, fixed metal block sits on a carrier module.

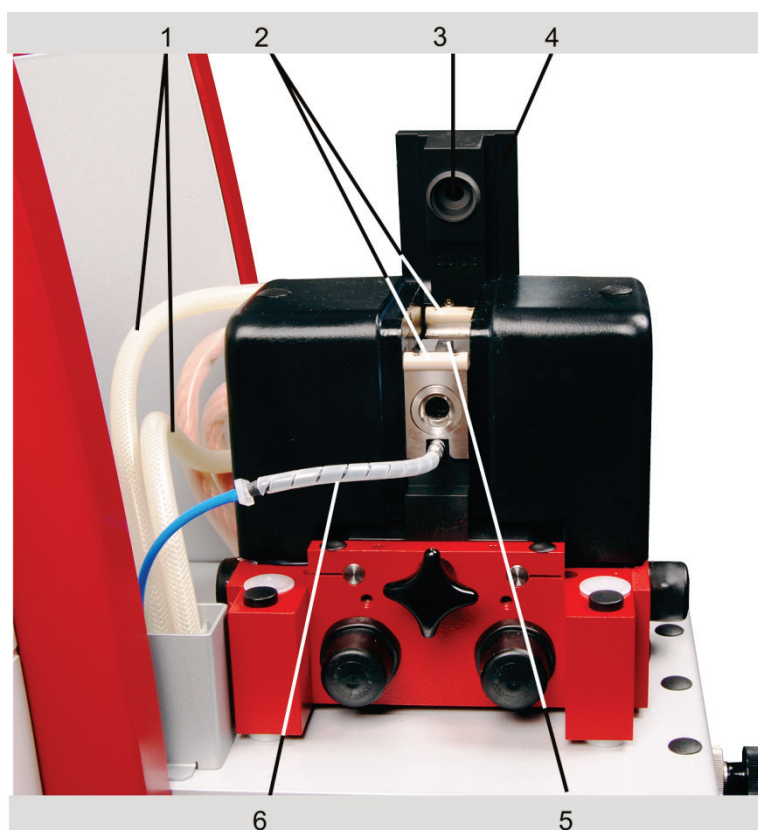

Fig. 7 Graphite tube furnace, open

| | | | |
|---|---------------------|---|---|
| 1 | Cooling water tubes | 4 | Upper metal block, in the open position |
| 2 | Furnace window | 5 | Graphite tube furnace jacket |
| 3 | Upper electrode | 6 | Protective gas supply |

The two metal blocks contain the connections required for current, protective gas and cooling water.

The vertical layout of the wings means that liquid samples are supplied by the autosampler AS-GF through the center of the upper wing.

Solid samples on a trough-shaped sample carrier (boat) can be supplied via the left horizontal furnace opening if the furnace windows are taken off and removed. The furnace jacket must be exchanged when changing between solution and solid forms of samples.

3.2.3 The Zeeman magnet

The Zeeman magnet consists of two similar U-shaped magnetic cores and two symmetrical coils. Both yoke halves are mechanically fixed and pressed against each other below the graphite tube furnace. At the top ends and directly behind the coils, the two yoke halves are beveled approximately to the cross-sectional area of the graphite tube furnace cavity. The polished end faces form the magnetic poles (pole shoes). In the area of the pole shoe, the graphite tube furnace is beveled to the extent that the pole shoes only have a clearance of 15 mm, which enables magnetic field strengths of 1.0 Tesla to be reached. The required magnetic field is homogeneously generated between the two pole shoes. Both poles shoes are shifted asymmetrically to the right (relative to the midpoint), and thus leave the necessary space for the solids autosampler.

3.2.4 Gas flows

The Zeeman graphite tube furnace houses the gas channels for the separate supply of the inner gas flow (purge gas) and the outer gas flow (protective gas).

The inner gas flow (purge gas) is directed into the furnace chamber through channels on both sides of the fixed furnace part on the inside of the (removable) furnace window. The two-part inner gas flow reaches the inside of the tube from the furnace windows and back out via the pipetter opening and the pipetter insert.

The inner gas flow has the task of removing all gases which occur in the graphite tube during the drying and pyrolysis step; also of preventing condensation effects of the analytes on the furnace windows and of influencing the residence time of the analyte atoms in the path of the beam. During atomization, the inner gas flow is generally interrupted in order to achieve the longest possible residence time for the atoms in the path of the beam of the graphite tube and to increase the sensitivity of the measurement.

Oxidizing or reducing gases (air or H_2) can be added to the inner gas flow if necessary. They have a positive effect on the pyrolysis step. When using air, temperatures $>650\text{ }^\circ\text{C}$ should be avoided since the graphite tube itself will then be attacked.

The outer gas flow flows through a channel in the fixed furnace part, the opening for the radiation sensor and the lower electrode into the furnace chamber. It sweeps the radiation sensor and the graphite tube and also reaches the outside through the pipetter insert. The outer gas flow is responsible for ensuring that the graphite tube is surrounded by inert gas, even when the inner gas flow has stopped, and thus provides protection against oxidation by atmospheric oxygen.

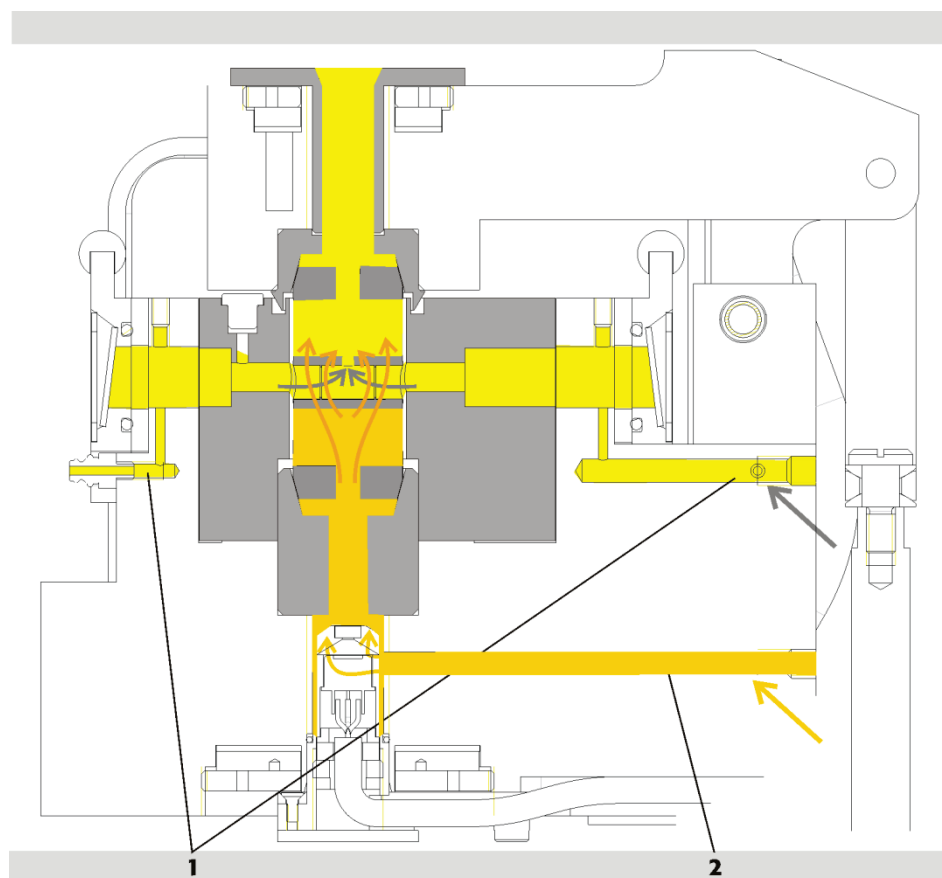

Fig. 8 Inner and outer gas flows in the graphite tube furnace

1 Inner gas flow (purge gas)

2 Outer gas flow (protective gas)

3.2.5 Graphite tube variations, furnace parts and inserts

Three graphite tube variations are available:

- Standard graphite tube
- Graphite tube for solid analysis
- Graphite tube with PIN platform

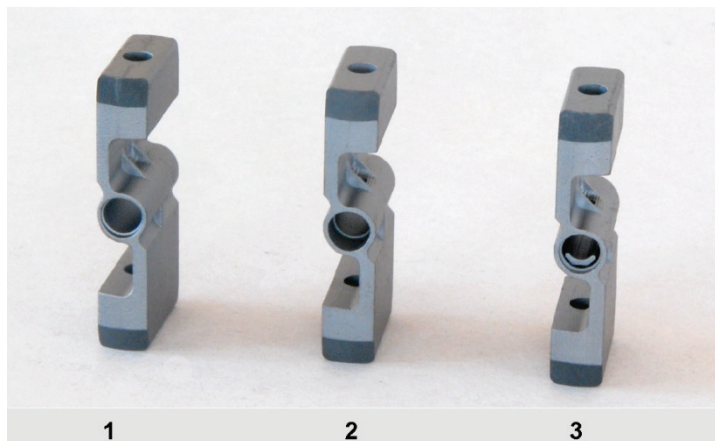

Fig. 9 Graphite tube variations

- 1 Graphite tube for solid analysis
- 2 Graphite tube, standard
- 3 Graphite tube with PIN platform

Table 1 Use and sample volume of different graphite tube variations

| Graphite tubes | Atomization | Sample volume/ quantity | Use |
|--|-------------|----------------------------|---|
| Standard graphite tube | Wall | Max. 50 μ L | Aqueous samples (samples not requiring complex analysis), alternative for solid samples |
| Graphite tube with PIN platform | Platform | Max. 40 μ L | Aqueous samples |
| Standard graphite tube for solid analysis (without dosing opening) | Boat | Max. 3 mg | Solids (solid technology) |

The wings of all tube types are drilled through. The hole in the lower wing serves as an observation channel for the radiation sensor. The hole in the upper wing lies in the extension of the pipetter opening as an access for pipetting in solution analysis.

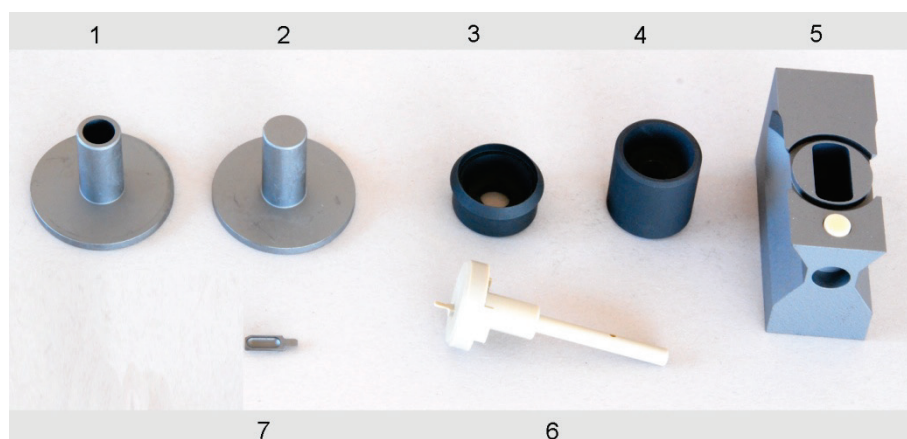

Fig. 10 Furnace jacket, adapters and inserts

Table 2 Furnace parts and inserts

| No. | Furnace Part / Insert | Function |
|-----|---|--|
| 1 | Pipetter insert (Z-insert) | Funnel opening to the pipetting channel. Protects exposed metal parts. Ensures contamination-free pipetting: |
| 2 | Solid adapter (Z sealing cup) | Seals the pipetter opening. Protects exposed metal parts. |
| 3 | Upper electrode | Contacts tube wing from above. |
| 4 | Lower electrode | Contacts tube wing from below. |
| 5 | Furnace jacket with horizontal hole going right through | Accommodates the graphite tube. |
| 6 | Adjusting aid | Adjusts the autosampler AS-GF and the solid autosampler SSA 600 |
| 7 | Boat (sample carrier) | Accommodates solids samples. |

3.2.6 Radiation sensor

The radiation sensor is used for recalibrating the tube temperature. It is fixed in the furnace holder and receives the radiation from the cylindrical part of the graphite tube through the drilled hole in the lower wing and through a concentric drilled hole in the lower electrode.

Using two wavelengths for detection, an independent quotient signal is derived for temperature measurement which is independent of the degree of radiation of the graphite tube. Recalibration takes place when formatting the graphite tube.

3.2.7 Furnace camera

As an option the ZEEnit 700 P can be fitted with a furnace camera. It monitors the process, beginning with the injection of the sample into the graphite tube through to completion of drying. The dipping of the dosing tube into the graphite tube, the dispensing of the sample and other components as well as the drying procedure can be controlled and corrected if necessary.

The camera looks into the graphite tube via a deflection mirror from the left, whose interior is illuminated by a LED from the right. The camera and the deflection mirror are mounted on a pneumatically actuated carriage and are moved into the path of the beam for observation. The illumination is rotated.

3.3 Accessories for the graphite tube technique

3.3.1 Autosampler AS-GF

The autosampler AS-GF is used in EA mode for feeding liquid samples and in the HydrEA method for feeding reaction gas into the graphite tube. Manual pipetting is not recommended because of the poor reproducibility rate.



Fig. 11 Autosampler AS-GF

The autosampler AS-GF accepts defined volumes of different solutions and places them into the graphite tube. It enables the

- Addition of up to five modifiers to the sample solution
- Transport of the sample solution to the thermal pretreatment in the tube
- Enrichment of samples
- Placement of components in the preheated tube
- Separate transport of components with intermediate washing
- Automatic preparation of standards by dilution or by different volumes
- Fixed, preselected or intelligent sample dilution
- Fully automatic multi-element mode (night mode possible)

The sample tray of the AS-GF has space for 100 sample cuts (with $V = 1.5$ mL) and 8 central cups for diluent, special samples, standards, modifiers etc. (with $V = 5$ mL).

The AS-GF is hung in the adapters provided in the sample chamber and electrically connected to the ZEEnit 700 P. The device parameters of the AS-GF are set with the ASpect LS control software.

3.3.2 Mobile cooling unit KM 5

Please observe the information provided in the instruction manual of the mobile cooling unit KM 5.

The graphite tube furnace of the ZEEnit 700 P is cooled by the mobile cooling unit KM 5 via a circulating cooling system. The working principle is an air-cooled heat exchanger with fan. The effective cooling power of the air-cooled mobile unit is therefore only available when the programmable set point is at least 7 °C above room temperature. The maximum set point value is 50 °C. The alarm value is always 15 °C above the set point value. If cooling performance is no longer effective, a temperature alarm contact switches off the cooler and the spectrometer.

The KM 5 has to be filled with 5 L of softened water (not distilled water). The cooling water temperature can be set.

3.3.3 Solid autosamplers SSA 600 and SSA6

The solid autosamplers SSA 600 and SSA 6 are absolute preconditions for solids analysis in the graphite tube technique. These enable reproducible placement of the IC sample carrier mounted with the solid sample into the graphite tube.

The solid autosampler SSA 600 enables automatic transport of solid samples into the graphite tube furnace. Weighing is performed fully automatically with an integrated microbalance. The solid autosampler SSA 600 has 84 sample positions when using 2 sample plates.

The SSA 6 has been conceived for manual operation and requires an external balance. The sample mass must be transferred manually to the sample table.

A full description of the solid autosamplers can be found in the operating instructions "Solid autosampler SSA 600" or "Solid autosampler SSA 6".

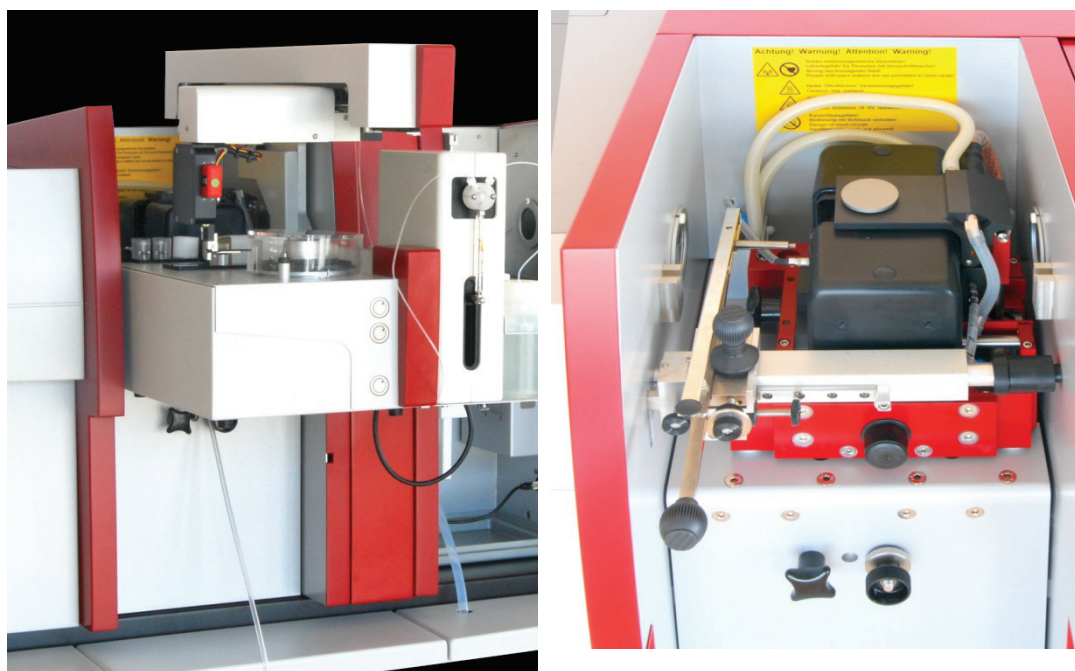

SSA 600 with liquid dispensing

SSA 6

Fig. 12 Solid autosampler on the ZEEnit 700 P

3.4 Flame system

Flame atomic absorption spectroscopy is used for the determination of trace elements in the concentration range from mg/L to $\mu\text{g/L}$ and for the determination of main components. The technique requires a flame with constant properties. The composition of the flame must be adjusted to the element to be analyzed. Motorized vertical adjustment of the nebulizer mixing chamber-burner system by 10 mm makes it possible to move the flame zone with the maximum absorption into the direction of the beam. For the measurement of main components, the burner can be swiveled by 90° on the connector until it is at a right angle to the beam thus shortening the absorption path of light through the flame.

The sample solution is aspirated by a pneumatic nebulizer and sprayed into the mixing chamber. In the mixing chamber, the sample aerosol is mixed with acetylene and oxidant before it emerges from the burner slot. The flame is either 5 or 10 cm long and a few millimeters wide, depending on the burner used. It is irradiated over its full length.

3.4.1 Gas automatic

The gas automatic ensures that the supply of acetylene and oxidant to the flame is free from pressure fluctuations and within the defined flow quantities. It enables safe and hazard-free ignition and quenching of the flame. The automatic gas control has three gas inlets for acetylene, air and nitrous oxide.

The fuel flow is set in steps of 5-L-between 40 and 315 NL/h acetylene by a proportional valve in the control path. The air flow first fills the store with a capacity of 500 cm^3 and is then released to the nebulizer. Air from the store is responsible for normal flame quenching and also for flame quenching in the event of an accident. Oxidant flow to the nebulizer is defined by its setting and the inlet pressure. If addi-

tional oxidant is used, the additional oxidant flow (air or nitrous oxide) is regulated in three levels.

The flame is ignited using a filament which is rotated out of the back of the sample chamber to the center of the burner. It is possible to switch over from the acetylene-air flame to the acetylene nitrous oxide flame by blocking the air supply, adding nitrous oxide, and increasing the acetylene flow. Quenching the acetylene nitrous oxide flame is carried out in the reverse order.

3.4.2 Burner-nebulizer system

Aerosol required by the sample solution for atomization in the flame is generated by the nebulizer. The oxidant flows into the nebulizer via a side connection and flows through the ring-shaped slit formed by the corrosion-proof platinum-rhodium alloy cannula and the PEEK nozzle. The resulting low pressure pulls the sample solution out of the cannula and aspirates more sample solution. The positioning of the cannula tip relative to the nozzle determines the aspiration rate. It can be set manually with an adjusting screw and lock nut.

The resulting sample aerosol strikes the baffle ball. Larger droplets condense on the baffle ball and run off via the siphon. The fuel gas flow strikes the surface of the baffle ball at a right angle. The generated aerosol flows through the mixing chamber to the flame at the burner. On the way through the mixing chamber, an equilibrium is reached. Other large droplets are separated by gravity and also run off via the siphon. The aerosol is atomized in the flame. The aerosol of the sample solution must have a small droplet size. Fast evaporation of drops when entering the flame is a precondition for atomizing the sample in the hot zone of the flame. If the sample does not fully evaporate, this has a negative effect on the accuracy of the analysis results. The background absorption is increased through scattering of the radiation by unevaporated droplets.

The setup of the mixing chamber nebulizer system optimizes the aerosol formation and ensures that the system is easy to maintain. The outlet into the siphon is located in the immediate vicinity of the nebulizer. Large drops drain off immediately and do not enter the mixing chamber. The impeller retains droplets and stabilizes the aerosol cloud. Potential liquid residues can continuously rise in the mixing chamber tube towards the nebulizer and drain off to the siphon. Furthermore, the baffle ball is permanently centered on the nebulizer so that a readjustment after cleaning the mixing chamber nebulizer system is not required.

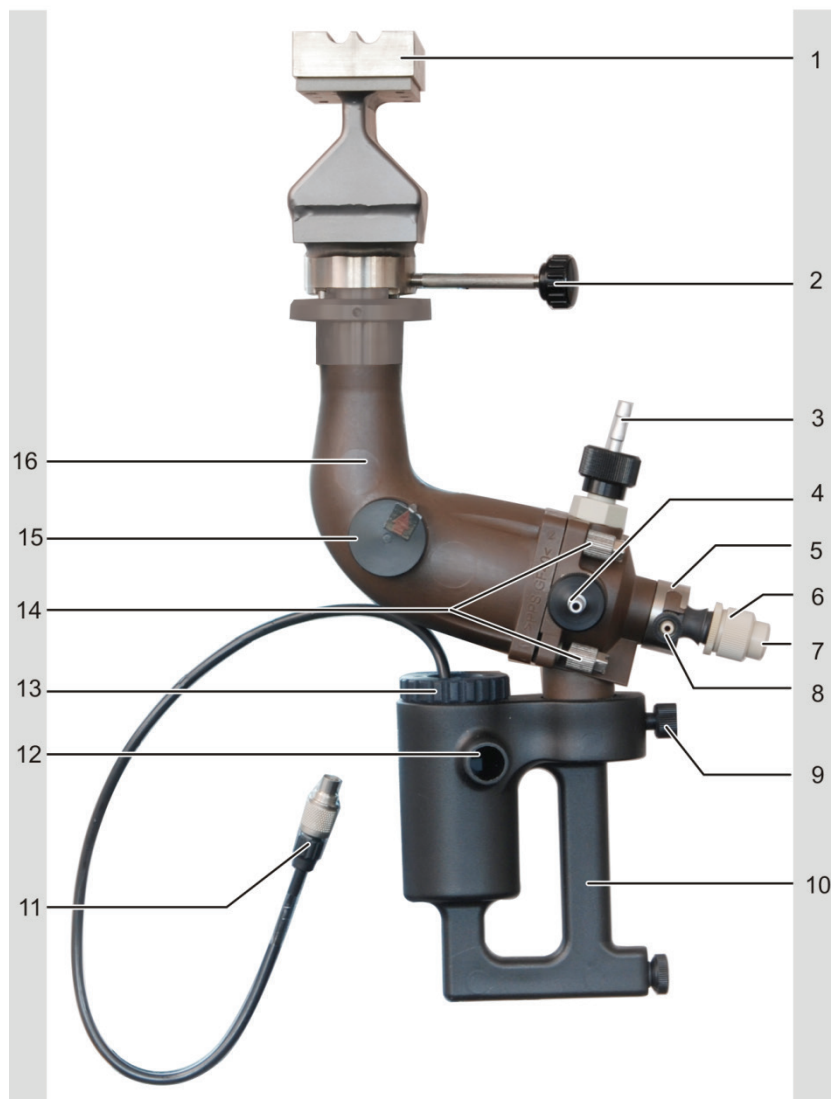

Fig. 13 Nebulizer mixing chamber burner system

- | | |
|------------------------------|---|
| 1 Burner | 9 Fixing screw for siphon |
| 2 Fixing screw for burner | 10 Siphon |
| 3 Combustion gas supply | 11 Connection of siphon sensor |
| 4 Additional oxidant supply | 12 Siphon outlet |
| 5 Locking ring for nebulizer | 13 Siphon sensor |
| 6 Nebulizer | 14 Screw joints of mixing chamber parts |
| 7 Sample liquid supply | 15 Safety plug |
| 8 Oxidant supply | 16 Mixing chamber tube |

3.4.3 Burner and flame type

The ZEEnit 700 P can be operated with the following types of flames and their corresponding burners:

- Acetylene-air flame with 50 mm one-slit burner (standard burner) or 100-mm-one-slit burner for higher sensitivity.
- Acetylene-nitrous oxide flame with a 50 mm one-slit burner.

If easily atomizable and difficult-to-atomize elements are part of the range of elements to be determined, only the 50 mm one-slit burner (standard) may be used to avoid a burner change between measurements.

Uses of the different flame types:

- Acetylene-air flame can be used for most elements.
- Acetylene-nitrous oxide flame is required for difficult-to-atomize elements such as boron, aluminum and silicon.

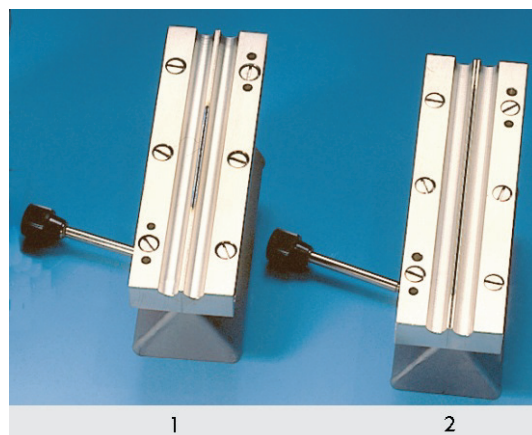

Fig. 14 Burner types

- 1 50 mm one-slit burner (standard burner)
- 2 100 mm one-slit burner

The burners made of titanium are inert with respect to the influences of aggressive sample solutions. The burners can be exchanged easily and can be infinitely variably rotated up to 90° between two stops. One stop is positioned in such a way that the burners are aligned to the optical axis. The 90° stop sets the non-sensitive diagonal position of the burners for determining main components.

3.4.4 Sensors

The burner-nebulizer system is checked by various sensors so as to guarantee operational safety.

- A float switch in the siphon indicates the correct level of 80 mm in the water column.
- Two reflex couplers identify the burner type by a code.
- A UV-sensitive sensor monitors the flame.

In addition to the above-mentioned sensors, the mixing chamber is also equipped with a safety plug which will fall out if the flame backfires into the mixing chamber.

The control software evaluates the sensor signals and also monitors the gas pressures and the gas flows as well as the status of the flame.

3.5 Accessories for the flame technique

3.5.1 Automatic samplers AS-F and AS-FD

Manual or automatic sample supply may be employed in the flame technique and the mercury/hydride technique. Automatic operation and multi-element analysis are possible if an autosampler is used. The parameters are set and the function is controlled with the ZEEnit 700 P control software.

The ZEEnit 700 P can be operated with the following autosamplers:

- The autosampler AS-F is an automatic autosampler.
- The autosampler AS-FD also has a dilution function.

The autosamplers use sample trays with the same diameter. The following sample tray types are available:

| | |
|---------------|--|
| 139 positions | Sample tray with 129 positions for 15 mL Sarstedt cups on the outer track and 10 sample positions for 50 mL Sarstedt cups on the inner track |
| 54 positions | Sample tray with 54 positions for 50 mL Sarstedt cups |

The sample trays should be selected according to the requirements of the analysis:

- Available sample volume
- Type of signal evaluation

The software controlled autosampler arm reaches all the positions intended for sample-taking. The dipping depth into the sample and the special cups is preset, however, it can be adjusted via the control software.

The ZEEnit 700 P supplies the autosamplers with operational voltage. Tray and autosampler arm are driven by stepping motors. The tray is rotated. The autosampler arm is rotatable and can be lowered by 120 mm.

On the top of the autosampler AS-F there is a wash cup with overflow next to the sample tray. In the autosampler AS-FD the wash cup is located in a plastic block together with a mixing cup. A diaphragm pump delivers the washing liquid from the supply bottle into the wash cup – this action cleans the dipped cannula by washing it inside and out. Excess washing liquid flows through the overflow into the waste receptacle, which is under the table during the wash cycle.

The autosampler AS-FD features an extra Fluidics module with a dosing unit (5000 µL). The Fluidics module is electrically connected to the autosampler and is supplied with operating voltage via the ZEEnit 700 P. Standards or samples are diluted in the mixing cup by first placing the concentrate into the mixing cup. Then the diluent is added at a high dosing speed (max. volume: $V = 25$ mL). A fixed waiting time ensures complete mixing. A second diaphragm pump extracts the residual liquid that has not been taken up by the nebulizer.

The autosampler AS-FD with dilution function features the following advantages:

- Preparation of standards for the calibration by diluting one or several stock standards in the mixing cup
- Dilution of the sample if its concentration is too high, i.e., its element content is higher than 110 % of the calibration standard with the highest concentration
- Dilution of all samples at freely selectable dilution ratios up to a ratio of 1:500



Fig. 15 Autosampler AS-FD with separate Fluidics module

- | | | | |
|---|----------------------------|---|-----------------------------------|
| 1 | Sample tray with cover | 4 | Storage bottle for diluent |
| 2 | Autosampler arm | 5 | Fluidics module |
| 3 | dosing unit (5000 μ L) | 6 | Storage bottle for washing liquid |

3.5.2 Piston compressor

If no in-house compressed air supply is available, a compressor should be used to provide the compressed air for the acetylene-air flame.

Analytik Jena offers the piston compressor PLANET L-S50-15 as an optional accessory. The compressed air is free from water, dust and oil. At a maximum operating pressure of 800 kPa and with a 15-L-air cylinder, the compressor is sufficient to meet the requirements for compressed air supply. For installation and maintenance of the device, please observe the information provided in the operating instructions of the piston compressor.

3.5.3 Injection module SFS 6

Injection module SFS 6 (Segmented Flow Star) is available as an optional accessory. It may be used in combination with an autosampler or in manual mode.

On the one hand, it allows washing or carrier solution to be aspirated continuously thus keeping the burner at a constant temperature by the aerosol, on the other hand it allows for reproducible measurements of small sample volumes relative to the washing or carrier solution.

The operating principle of injection module SFS 6 is based on a magnetic valve with two inlets and one outlet to the nebulizer. The sample aspiration tube is located at the energized inlet. It is dipped directly into the sample or is connected to the autosampler cannula. The non-energized inlet is connected to the aspiration tube for the washing or carrier solution. The two switching states are:

- Basic state: Sample path is blocked, carrier solution path is free.
- Active state: Sample path is free, carrier solution path is blocked.

The parameters for controlling injection module SFS 6 are entered with the control software.

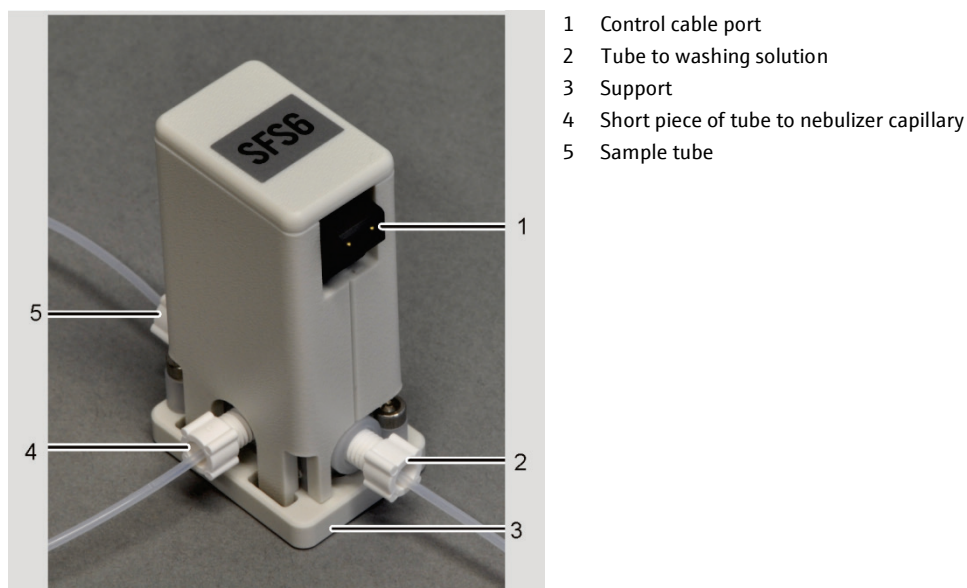

Fig. 16 Injection module SFS6

3.5.4 Scraper – automatic burner head cleaner for nitrous oxide flame

The automatic burner head cleaner (scraper) is recommended for continuous and fully automated operation with the nitrous oxide flame. When working with the nitrous-oxide flame and particularly the fuel-rich C_2H_2/ N_2O flame, as is used for the analysis of such elements as Si, W, Mo and Sn, carbon will deposit on the burner slot over longer periods. If these deposits are not removed completely, this will lead to clogging of the burner slot, which in turn will result in irreproducible measurement results. Using the scraper, the cleaning procedure can be fully automated.

Once activated in the software and stored as a method parameter, the scraper guarantees a continuous and reproducible measuring process without any disturbances and interruptions. You can choose among various cleaning intervals depending on flame composition and need. On the other hand, the scraper can also be used for the automation of the burn-in process of the nitrous-oxide flame. If activated in the flame monitor, a cleaning step is carried out every 30 s. This way, undisturbed burning in of the nitrous oxide flame is possible.

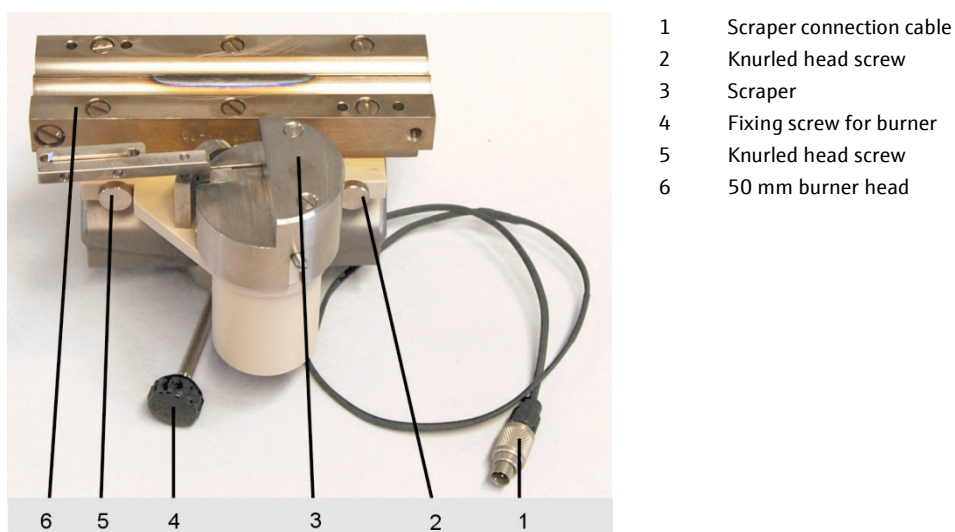

Fig. 17 Scraper mounted to 50 mm burner head

The scraper is fixed to the burner head with two knurled head screws. It can be detached if it is not needed. The scraper can be retrofitted on a 50 mm burner.

3.6 Supplementary accessories – Hg/hydride systems

The Hg/hydride systems available range from the simple batch systems for users with small samples through to fully automated continuous devices with flow injection.

| | |
|----------------|---|
| HS 50: | Hydride injector. Simplest batch system with pneumatic working principle. The quartz cell is heated by the acetylene-air flame. |
| HS 55 modular: | batch system with electrically heated cell unit with or without "Hg Plus" module for Hg detection. The reduction agent solution is metered by a 1-channel hose pump. |
| HS 60 modular: | Hg/hydride system for flow injection operation with electrically heated cell unit with or without "Hg plus" module for Hg detection. |

More information on the Hg/hydride systems can be found in the relevant accessory manuals.

3.7 Lamp turrets and lamps

The ZEEnit 700 P has an 8-lamp turret with a write/read unit for coded lamps at the active position. The coded lamps are fitted with transponders. The following is saved: lamp type, element(s), serial number, maximum recommended lamp current and boost current and operating hours. The use of uncoded lamps is possible. The lamp turret is designed for hollow cathode lamps with a standard bulb diameter of 37.1 mm. The individual lamps are rotated (PC-controlled) into the beam path, switched on and adjusted relative to the pitch circle in steps of 0.1 mm-

A second heat circuit ensures that a second HCL can be preheated at the same time.

Positions 5 to 8 can also be mounted with super- hollow cathode lamps. The required supply for boost current and heating is integrated and can be switched for either one of the positions 5 to 8. If a super- HCL is used as an active lamp, a second super- HCL cannot be preheated as such, only as a HCL. Therefore, for the multi-element routine it is recommended to have an element method with a super HCL followed by a method with a normal HCL.

Using a super hollow cathode lamp is advantageous for some elements such as, Se, Te, P, Zn due to the higher intensity of radiation, which enables the signal to noise ratio and the detection limit to be improved.

For mounting the 8-lamp turret, the following combinations can be used:

- 8 coded hollow cathode lamps or multi-element- hollow cathode lamps.
- 1 to 4 coded super- hollow cathode lamps at positions 5 to 8 and the remaining positions with coded hollow cathode lamps or multi-element- hollow cathode lamps.

The continuum radiator, a deuterium hollow cathode lamp (D2HCL), is installed in a holder.

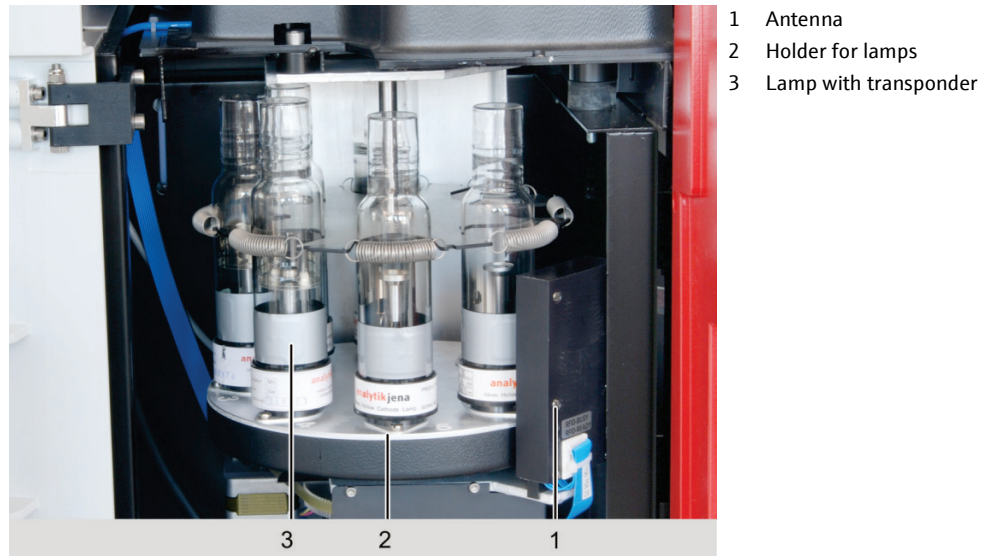

Fig. 18 Setup of the lamp turret

4 Installation and initial start-up

The device may only be assembled, installed and repaired by service engineers from Analytik Jena or by technical personnel authorized by Analytik Jena.

Any unauthorized interference limits warranty entitlements. When installing and starting up your machine, please observe the safety instructions in Section "Safety instructions" p. 9. Compliance with these safety instructions is a requirement for error free installation and the proper functioning of your AAS measuring environment. Always observe all warnings and attention messages which are displayed on the device itself or which are displayed by the control program of the ZEEnit 700 P.

For error-free operation of the ZEEnit 700 P, please ensure that the user instructions described in Chapter "Installation conditions" are always complied with. If the ZEEnit 700 P has to be moved, please follow the instructions in Chapter "Transport and storage" p. 104.

4.1 Installation conditions

When setting up assistance is needed for part of the time. The service engineer will test the device and document the test in the test report of the ZEEnit 700 P.

The operator is responsible for everything which is not included in the original delivery, but which is necessary for operation of the ZEEnit 700 P. Operation of the ZEEnit 700 P demands certain local and system-specific requirements:

- Suitable place for assembly
- Space
- Environmental conditions
- Supply of inert gas, fuel gas, oxidant
- Exhaust unit
- Mains connection

Possible dangers when working with the ZEEnit 700 P are:

- Danger of burning by flame and hot burner and furnace parts
- Danger from electric current
- Danger of UV radiation
- Danger of ozone or nitric oxide formation
- Danger when handling pressure cylinders
- Danger from toxic and chemically aggressive substances
- Danger due to strong magnetic field

4.1.1 Environmental conditions

- Do not set up the ZEEnit 700 P directly beside a door or a window. The work space of the ZEEnit 700 P should be free of draft, dust, corrosive vapor and also vibrations.
- Do not set up the ZEEnit 700 P close to any electromagnetic source.
- Avoid direct sunlight and heater radiation on the ZEEnit 700 P. In extreme cases, provide acclimatized conditions in the room.

- A separate room is recommended for preparing samples and storing wet-chemical materials.
- There is a no smoking policy in the room where the ZEEnit 700 P is operated.

The following ambient conditions must be met by the operating room:

| | |
|---------------------------|------------------------------|
| Temperature range | +10 °C to +35 °C |
| Humidity during operation | Max. 90 % at 30 °C |
| Transport temperature | -40 °C to +70 °C (desiccant) |
| Recommended max. altitude | 2000 m |

4.1.2 Energy supply



WARNING

Observe the mains connection!

During electrical installation, observe any local regulations! The mains supply must be correctly earthed. Do not use an adapter in the mains cabling.

The ZEEnit 700 P is operated on single-phase alternating current. The current load can reach 85 A for a short period (1 s) during maximum heating. The mains voltage at the ZEEnit 700 P should not decrease by more than 6 % during this period. For any deviation from these values, please contact Analytik Jena. Appropriate accessories can be supplied.

Optimum device function strongly depends on a correct mains connection with adequate cable cross-section. The mains connection shall be protected on the input (building) side with a 35 A slow-blow fuse and must be installed prior to delivery of the ZEEnit 700 P near the assembly point. The instrument cable is 3 m long. The CEE surface socket (2 pole + E Blue 5UR 3 206-2 220/32, Siemens) is supplied according to the terms of delivery.

The mains plug is used to isolate the device from the power supply. Therefore make sure that the mains plug is easily accessible.

The auxiliary components that are to communicate with each other, for example PC, monitor, printer and hydride system, have to be connected to the power strip that is supplied with the device. The power strip is plugged into the rear of the AAS is connected to the same phase as the base device itself. The compressor needs a separate power supply.

If you use your own PC-printer configuration, and if it is connected via the 5-way multiple adapter, observe the limit of the permitted line current (a total of 5 mA with auxiliary devices). To avoid sudden voltage fluctuations, do not connect the ZEEnit 700 P to the same electrical circuit as other power-intensive devices.

Switching on conditions

| | |
|---|---|
| Voltage | 230 V ~ |
| Frequency | 50/60 Hz |
| Typical average power consumption | 2100 VA |
| Maximum current consumption | 85 A over a 1-sec period or 52 A over 8 sec |
| Fuse provided (mains side) | 35 A, safety fuse, slow blow, single phased Do not use automatic fuse devices! |
| Power consumption of the hydride system | 650 VA while heating the cell 400 VA in continuous operation |

4.1.3 Gas supply

**WARNING**

Risk of explosion due to leaking acetylene! Risk of the build-up of an oxygen-deficient atmosphere caused by leaking gas!

The operator must ensure that the connector type used on the outlet side of the gas pressure controller complies with the national requirements.

The operator must carry out the necessary safety leakage tests on all gas supply lines and connectors including those on the device on a weekly basis. For this, possible pressure losses from closed systems and lines under pressure are to be determined. The leak is to be localized and corrected immediately. If the gas is supplied via compressed gas cylinders, these must be attached to the wall with cylinder mounts in an upright position outside the laboratory.

Gases in the graphite tube technique

The required inert gas is used to protect the graphite components of the atomizer, which are subjected to extreme temperatures. The inert gas is also used as a means of transport for the pyrolysis components accrued during the analysis. The purity of the inert gas is extremely important for the analysis and for the lifetime of the graphite tube.

By the introduction of an auxiliary gas (in addition to the inert gas and not instead of it) during the pyrolysis step (e.g., air), the ashing of the sample, i.e., the removal of the matrix components, can be accelerated. The auxiliary gas is fed in through the "Gas Auxiliary" connection on the rear of the device.

The gas pressure at the spectrometer must be between 600 and 700 kPa.

The standard length of the hose is 5 m. If other tube lengths are preferred, please contact the customer service department at Analytik Jena.

Table 3 Gases in the graphite tube technique

| Recommended inert gas | Inlet pressure | Consumption |
|-----------------------|----------------|---|
| Argon 4.8 or superior | 600 to 700 kPa | Max. 2 L/min |
| Permitted components: | | (depending on the temperature-time program) |
| Oxygen ≤3.0 ppm | | |
| Nitrogen ≤10.0 ppm | | |
| Hydrocarbons ≤0.5 ppm | | |
| Humidity ≤5.0 ppm | | |

Gases in the flame technique

For the flame technique, oxidant (compressed air and N₂O if necessary) and acetylene are required as fuel gas. The purity of the gases is extremely important for the analysis. A piston compressor can be used to supply the compressed air. If compressed air is supplied by the operator's own compressed air connection, please consult the service department at Analytik Jena. N₂O is supplied by pressure cylinders or by an existing mains line.

The pressure tubes are supplied. The pressure reducing valves are optional.

- Tubing length cylinder connection 5 m
- Tubing length for the compressor 5 m

It is also possible to connect other tube lengths. Please consult the service department at Analytik Jena.

Table 4 Gases – flame technique

| Fuel gas and oxidant | Inlet pressure | Consumption |
|--|----------------|---------------|
| Compressed air, oil-free, grease-free, particle-free | 400 to 600 kPa | Max. 775 NL/h |
| N ₂ O, oil-free, grease-free, purity 2.5 | 400 to 600 kPa | Max. 620 NL/h |
| Acetylene Purity ≥2.5 (for flame photometry or analytics): Superior to 99.5 vol% relative to C ₂ H ₂ , without acetone, additional components: hydrogen compounds of As, S and P | 80 to 160 kPa | Max. 315 NL/h |

4.1.4 Exhaust unit



CAUTION

Risk of poisoning due to leaking gases!

Switch on the exhaust unit prior to starting the ZEEnit 700 P. Extract the exhaust air from the laboratory and prevent congestion!

Correct exhaust is only achieved with two exhaust hoods that are installed directly above the two sample chambers, or with a rotatable exhaust hood.

The exhaust unit should remove health-damaging burning residues from the flame as well as any ozone which has resulted. Ozone is caused by the reaction of air and UV radiation from the hollow cathode lamps, from the graphite tube furnace at temperatures above 2000 °C and from the burner flame. Use an exhaust unit made of heat and corrosion-proof material. The first 6 m of the exhaust unit should be made of metal.

Table 5 Exhaust unit requirements

| Parameter | Properties |
|---|-------------------------------------|
| Material | V2A |
| Exhaust performance for nitrous oxide flame | Approx. 8 to 10 m ³ /min |
| Exhaust performance for air flame | Approx. 5 m ³ /min |
| Exhaust performance for graphite tube | Approx. 1 m ³ /min |

| Parameter | Properties |
|---|-------------------------------|
| Exhaust performance for graphite tube for samples with acid concentration > 5 % | Approx. 5 m ³ /min |
| Hood opening | Approx. 300 × 300 mm |
| Distance to the upper edge of the device | Approx. 200 to 300 mm |
| Tube diameter | Approx. 100 to 120 mm |

4.1.5 Water cooling

The graphite tube furnace of the ZEEEnit 700 P is cooled via a cooling system of the mobile cooling unit KM 5. Please observe the information provided in the instruction manual of the mobile cooling unit KM 5.

The KM 5 has to be filled with 5 L of softened water (not distilled water). The cooling water temperature can be set.

Table 6 Water cooling

| Parameter | Properties |
|-----------------------------|------------------|
| Length of the water tubing | 2.0 m |
| Length of the power cable | 2.7 m |
| Length of the control cable | 2.0 m |
| Water rate | 300 kPa; 3 L/min |

To operate on a 60 Hz network, a special model of the mobile cooling unit KM 5 is necessary.

4.1.6 Space requirement, weight and device layout

The ZEEEnit 700 P is a compact device, conceived for mounting on a table. The space required is a function of all components needed for the measurement.

The PC with the monitor, the printer and the keyboard are arranged beside the base device. The PC and the printer can also be placed on a regular PC table.

The samplers for the flame mode AS-F or AS-FD are hung in the right sample chamber of the ZEEEnit 700 P. The storage bottle for wash liquid of the AS-F or the Fluidics module of the AS-FD are placed next to the AAS device.

The accessories for the graphite tube technique – autosampler AS-GF for dissolved samples or Solid Autosampler SSA 6 or SSA 600 for solid samples – are hung in the left sample chamber.

The accessories for the mercury/hydride technique are placed either on a large tray or on an additional table to the left of the ZEEEnit 700 P (HS 55 modular, HS 60 modular) or they are hung in the sample chamber (HS 50).

The following are located on the floor near the device:

- The receiving bottle for unnebulized sample liquid, autosampler wash liquid and residue liquid of the mercury/hydride system
- The compressor
- The KM 5 must have at least 15 cm of free space at both sides to ensure optimum air circulation for the cooling air inflow and outflow.

Table 7 Measurements and weights of the components of the ZEEnit 700 P

| Components | Width [mm] | Height [mm] | Depth [mm] | Weight [kg] |
|--------------------------|-------------|-------------|------------|-------------|
| On the work table | | | | |
| ZEEnit 700 P | 1180 | 650 | 735 | 225 |
| AS-GF | 250 | 550 | 380 | 7,2 |
| AS-F | 340 | 350 | 460 | 6,5 |
| AS-FD | | | | |
| Autosampler | 340 | 350 | 460 | 6,5 |
| Fluidics module | 360 | 310 | 165 | 3,5 |
| HS 60 modular | 360 | 370 | 240 | 14 |
| HS 55 modular | 360 <td 370 | 240 | 14 | |
| HS 50 | 270 | 210 | 190 | 2 |
| SSA 6 | 260 | 90 | 260 | 1 |
| SSA 600 | 300 | 370 | 500 | 10 |
| Under the work table | | | | |
| Compressor | ∅ 400 | 490 | | 27 |
| Mobile cooling unit KM 5 | 300 | 600 | 500 | 32 |

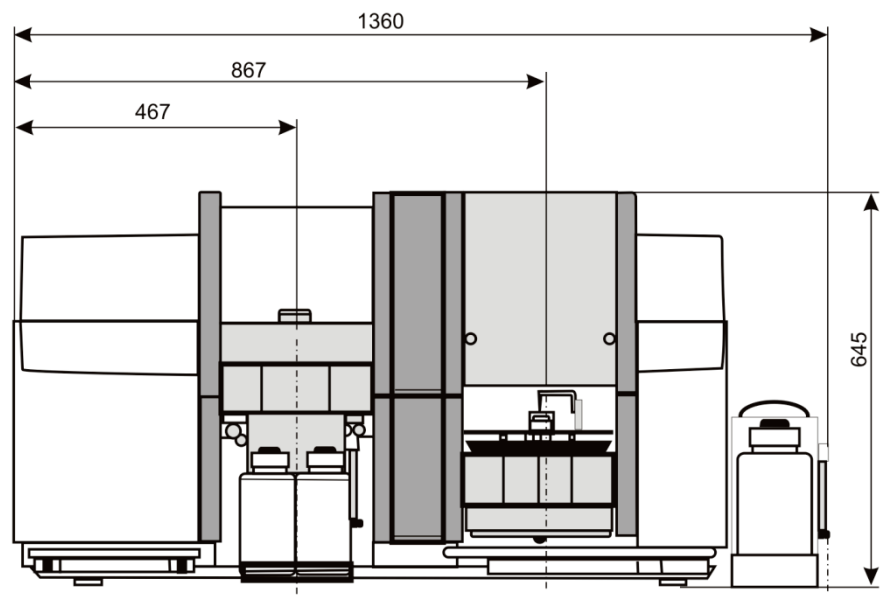

Fig. 19 Dimensions of the ZEEnit 700 P – front view

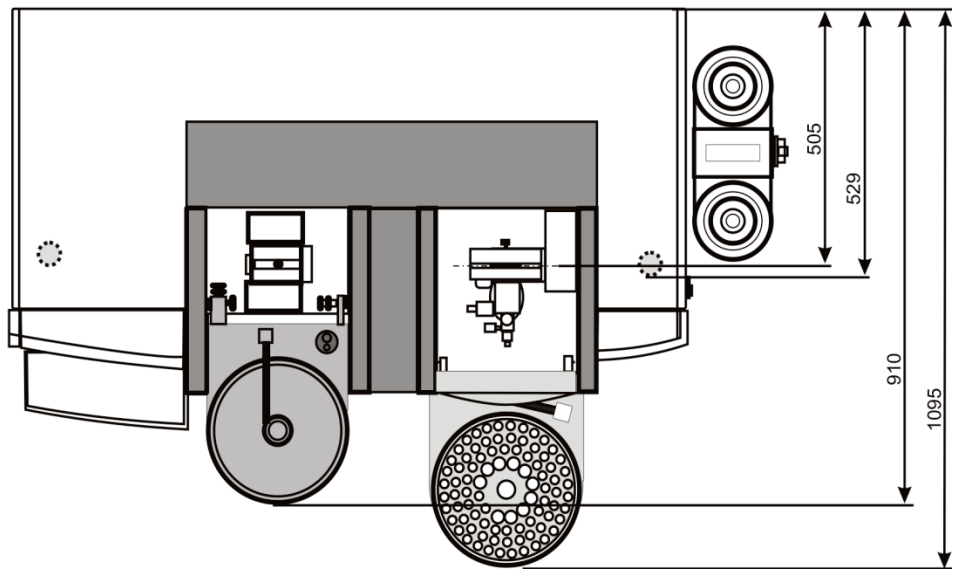

Fig. 20 Dimensions of the ZEEnit 700 P – top view

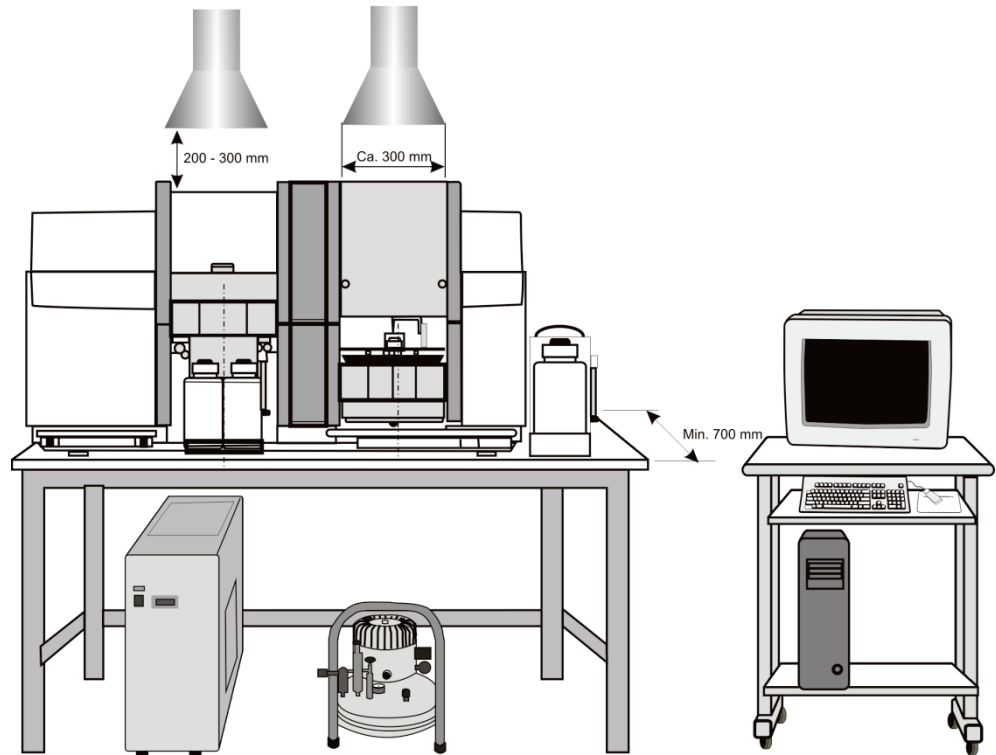

Fig. 21 Installation layout of the ZEEnit 700 P

4.2 Supply and control connections

The supply lines are connected during the assembly of the ZEEnit 700 P by service engineers from Analytik Jena.

The mains switch is located on the right side of the ZEEnit 700 P. The right side also has easily accessible connections for PC and accessories. The media connections for gas, water and electricity as well as the fuses are located at the rear.

A pair of carrying rods are fastened to the left and right for transport and assembly. After assembly the bars are unscrewed and the openings sealed with the stoppers supplied.

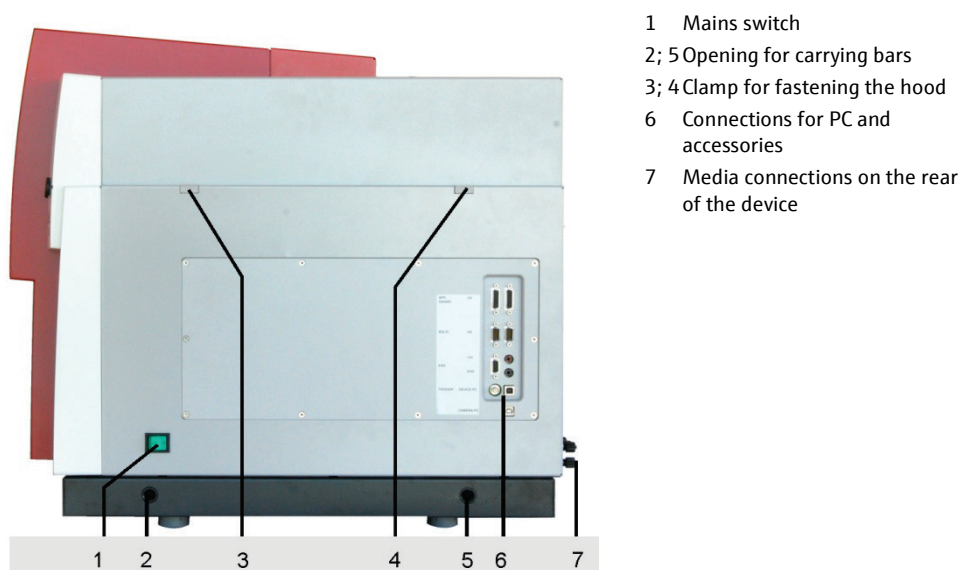

Fig. 22 Mains switch and bar for supply and control connections

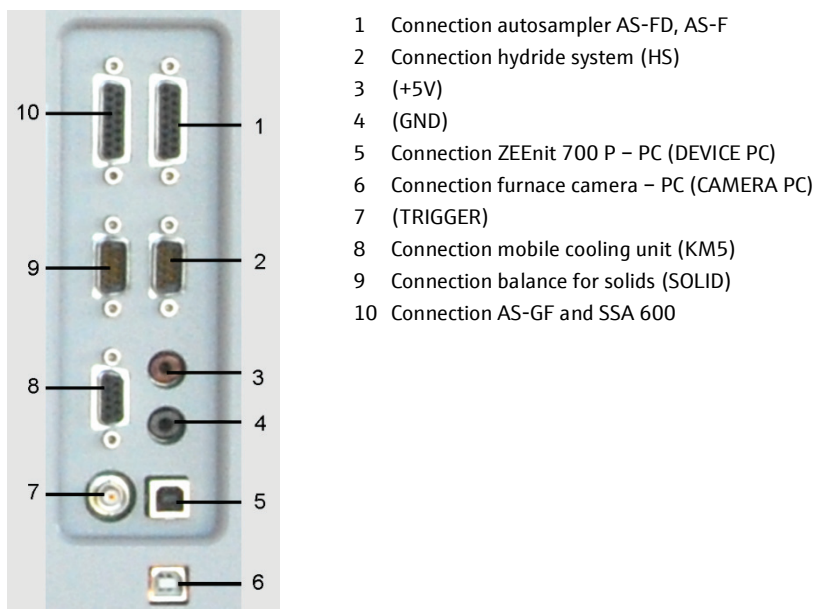

Fig. 23 Bar for supply and control connections

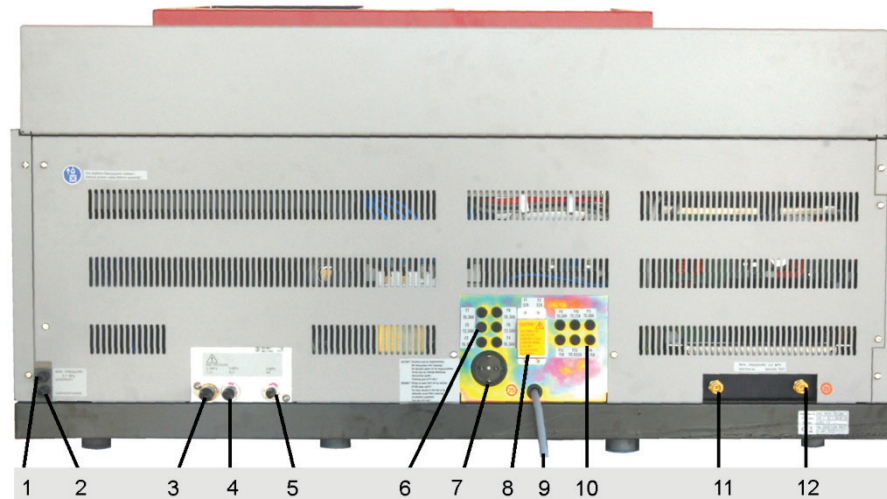

Fig. 24 Rear view of the AAS with connections for gas, electricity and water

- | | |
|---|--|
| 1 Connection inert gas | 8 Fuses F1, F2 |
| 2 Connection auxiliary gas | 9 Mains connection line for ZEEnit 700 P |
| 3 Connection fuel gas (C ₂ H ₂) | 10 Fuses F9 - F14 |
| 4 Connection nitrous oxide (N ₂ O) | 11 Cooling water inlet "Water in" |
| 5 Connection air | 12 Cooling water outlet "Water out" |
| 6 Fuses F3 - F8 | |
| 7 Mains connection for accessories (5-way multiple adapter) | |

4.3 Removing the transport lock



NOTICE

The transport lock must be removed by service engineers from Analytik Jena or technical personnel authorized by Analytik Jena.

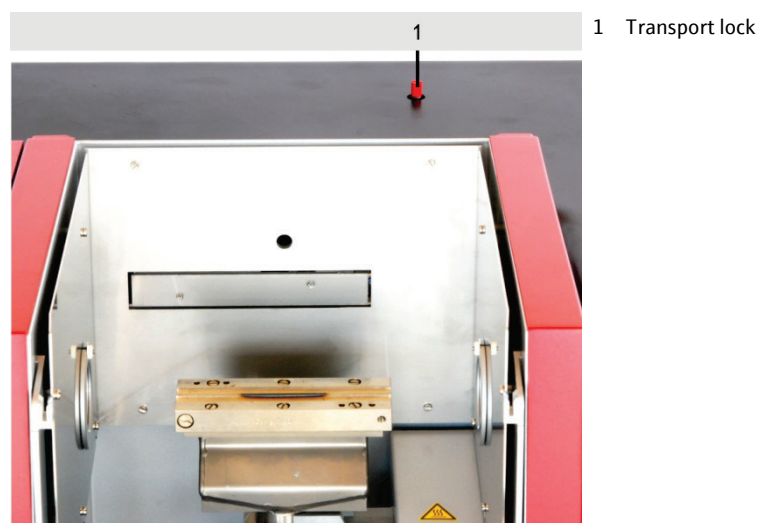

Fig. 25 Transport lock on the ZEEnit 700 P

1. Unscrew and remove the clamps for the device cover on the left and right side walls (3 and 4 in Fig. 22).

2. Remove the device cover.
3. Unscrew the red-marked transport lock from the grid lever.
4. Fit on the cover of the device and fasten the clamps on the left and right side walls.

4.4 Installing the ZEEnit 700 P

Auxiliary materials

- 4 stoppers, plastic
 - 19 mm open-end wrench (included in scope of supply)
1. Unscrew and remove the four handles and keep in a safe place.
 2. Seal the openings with stoppers.
 3. Install the gas supply:
 - Tighten the acetylene gas connector with a 19 mm open-end wrench. Left hand thread!
 - Fix the argon tube to the screwed tube connection.
 - Fasten the air tube to the screwed tube connection.
 - Fix the nitrous oxide tube to the screwed tube connection.
 4. Check the gas connections for leaks (→ Section "Supply and control connections" p. 47).
 5. Install the mobile cooling unit KM5 (→ Section "Installing the mobile cooling unit KM 5" p. 49).
 6. Establish the electrical connection for the ZEEnit 700 P (→ Section "Energy supply" p. 41).
 7. Connect the PC and the ZEEnit 700 P with USB cable (5 in Fig. 23 p. 47).
 8. Further work steps: Install the ASpect LS software. Complete the ZEEnit 700 P according to the desired atomization techniques.

4.5 Installing the mobile cooling unit KM 5

For all information on installation, operation and maintenance, consult the supplied instruction manual "Mobile Cooling Unit KM5".

1. Fill the mobile cooling unit KM 5 (see Section "Mobile cooling unit KM 5" p. 101).
2. Set up the cooling circuit: Push the tube connector onto the AAS and KM 5.
At the KM5 (below): "Water inlet" ► On the ZEEnit 700 P: "IN"
At the KM5 (above): "Water return flow" ► On the ZEEnit 700 P: "OUT"
3. Connect the control cable of the KM 5 to the appropriately marked connector on the right wall of the ZEEnit 700 P (see Fig. 23).

Note: The service button of the KM 5 remains at "OFF", i.e., the green operating light does not light up. This is the only way of ensuring that the mobile cooling unit be controlled by the ZEEnit 700 P control software.

4. Bleed the cooling circuit (→ Section "Mobile cooling unit KM 5" p. 101).

4.6 Installation and start of the ASpect LS program

For the installation and start of the ASpect LS program, which is required for controlling the spectrometer, refer to the Manual "ASpect LS."

4.7 Mounting the 8-lamp turret and lamp adjustment



WARNING

Risk of skin and eye damage caused by UV radiation! Turn off the lamp current before opening the lamp chamber.

To do so, open the section OPTICAL PARAMETERS in the SPECTROMETER / CONTROL window of the ASpect LS software and set the lamp current [mA] to zero. Open the drop-down list BACKGROUND CORRECTION and select the option NO BACKGROUND. Click [SET]. Negate the error message.



CAUTION

Risk of burns! Allow lamps to cool down before replacing them.



NOTICE

Risk of damage to the lamp! Do not touch the lamp window. Remove and install lamps only when the device is de-energized.

An 8-lamp turret can be mounted as follows:

- The 8-lamp turret should preferably be mounted with coded hollow cathode lamps.
- The use of uncoded lamps is also possible.
- The positions 5 to 8 can also be mounted with super hollow cathode lamps.



Fig. 26 Setup of the lamp turret

- | | | | |
|---|--|---|----------------|
| 1 | Hollow cathode lamp | 4 | Tension spring |
| 2 | Position of the lamp turret for removal and installation of the HCLs | 5 | Lamp socket |
| 3 | Prism holders for HCL | | |

4.7.1 Removing and installing the hollow cathode lamp

1. Open the door to the lamp chamber.
 2. Unhook the tension spring.
 3. Remove the lamp from the lamp socket.
- Note:** Do not touch the lamp window!
4. Plug the new lamp into the lamp socket, hook the tension spring in again.

4.7.2 Removing and installing the deuterium hollow cathode lamp

1. Turn off the lamp current.
2. Remove the cover plate of the D2HCL holder from the device cover.
3. Unscrew the three fixing nuts (arrow in Fig. 27) and remove the lamp holder.
4. Unscrew the retaining screw (6 in Fig. 28). Pull the lamp socket from the lamp.
5. Carefully pull out the lamp under the tension spring (1 in Fig. 28).
6. Place the new lamp carefully under the tension spring and push it to the stop (2 in Fig. 28).

Note: Do not touch the lamp window!

7. Put the socket on the lamp. Screw in the retaining screw.
8. Adjust the lamp axis parallel to the mount of the holder (by eye): Change the position of the lamp (4 and 5 in Fig. 28) with the long fine adjusting screws.
9. Fit on the holder and screw on the fixing nuts loosely. They are tightened by hand only after the adjustment.

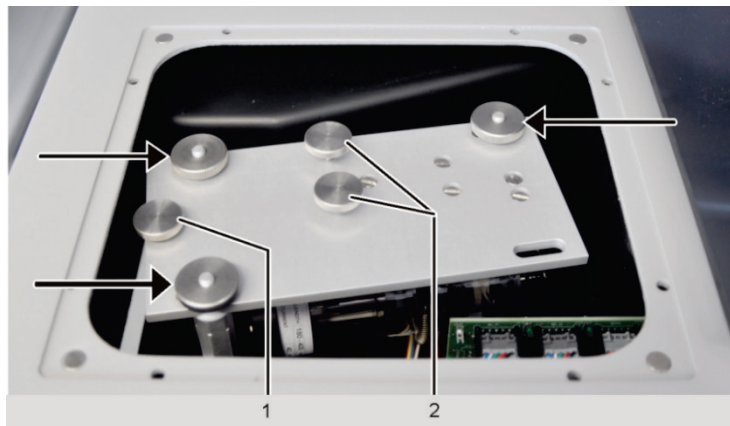

- Arrows
- Fixing nuts of the lamp holder
 - 1 Retaining screw for the lamp socket
 - 2 Adjusting screws

Fig. 27 D2HCL holder installed in the lamp chamber

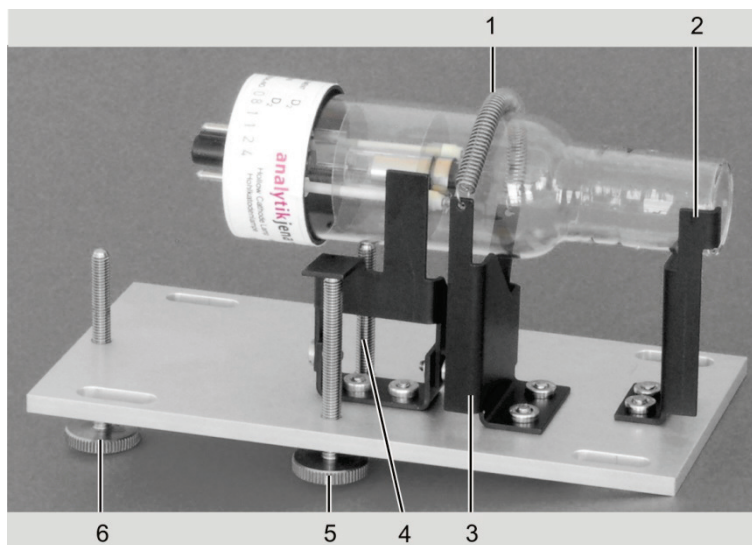

Fig. 28 D2HCL with the holder removed from the lamp chamber

- | | |
|------------------|---------------------------------------|
| 1 Tension spring | 4; 5 Fine adjusting screws |
| 2 Stop | 6 Retaining screw for the lamp socket |
| 3 Support | |

4.7.3 Setting up the lamp turret in ASpect LS

Coded lamps

If coded lamps are available, the data which is important for the method of analysis and which is saved on the transponder, such as the lamp type, elements, maximum and recommended lamp current as well as maximum and recommended boost current, is read out in the active position during initialization and entered in the table with the assignment to the lamp turret position.

Uncoded lamps



NOTICE

Observe the lamp position! If the hollow cathode lamps are not coded, the lamps must only be mounted according to their entered positions in the turret.

1. Click the  icon to call up the Spectrometer window and go to the Control tab.
2. Use the [LAMP TURRET] button to open the corresponding window.
3. In the table, highlight the lamp turret position that is to be mounted with a lamp or which is to be changed.
4. Use [CHANGE] to open the SELECT LAMP/ELEMENT window.

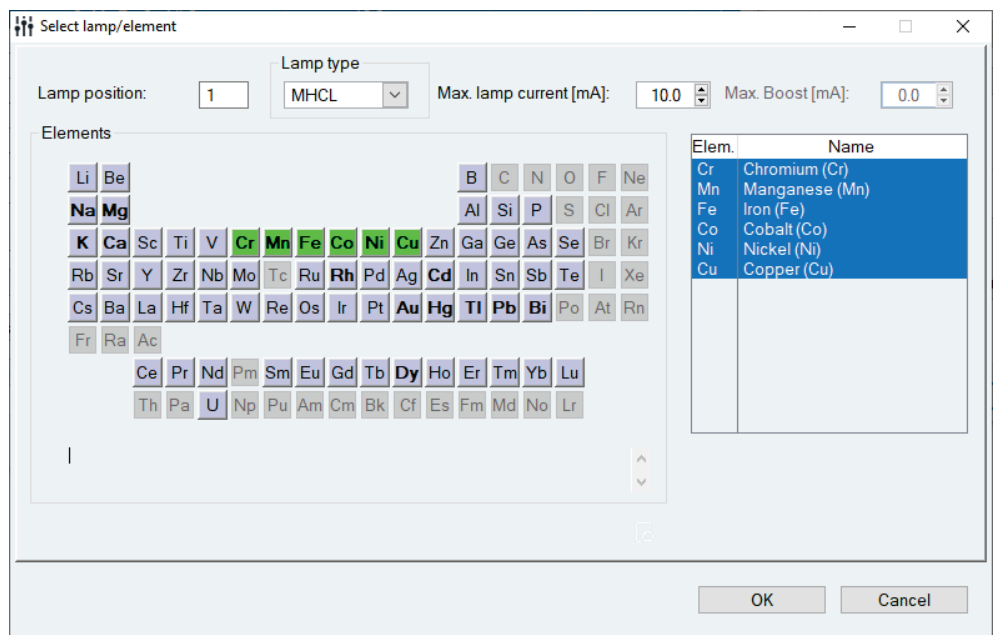

Fig. 29 Select lamp/element window

5. Enter the following values:

| | |
|----------------|---|
| LAMP POSITION | Shows the position in the lamp turret. Cannot be edited in this window. |
| LAMP TYPE | For selecting the lamp type. The selection is based on the lamp position and the lamp types available at the position. S-HCL and S-MHCL are only available at the positions 5 to 8. NONE The position does not contain a lamp. HCL Single-element hollow cathode lamp M-HCL Multi-element hollow cathode lamp S-HCL Single-element super hollow cathode lamp S-MHCL Multi-element super hollow cathode lamp |
| CURRENT | For setting the maximum lamp current. |
| BOOST | Only for S-HCL and S-MHCL; For setting the maximum boost current. |
| PERIODIC TABLE | Click with the cursor on the element symbol in the periodic table to select the lamp element: <ul style="list-style-type: none"> ■ Blue buttons indicate selectable elements. Gray (inactive) buttons indicate elements that cannot be analyzed with the AAS technique. Green buttons indicate selected elements. |

- For M-HCL and S-MHCL several elements can be selected. Click on the element symbol again to cancel the selection. Selected elements are displayed in the table on the right.

6. Click [OK] to exit the SELECT LAMP/ELEMENT window and return to the LAMP TURRET window.

- ✓ The lamp specification is entered into the table of the LAMP TURRET window.

4.7.4 Adjusting the lamps

Fine adjusting the lamps is generally required only once after new installation of the lamp.

Maximizing the lifetime of the lamp

The lifetime of the lamp is strongly dependent on the current setting for the lamp. The recommended operating current varies from lamp type to lamp type. For the following adjustment, observe the instructions in the cookbook of the ASpect LS software, the Analytik Jena operating instructions for the various lamps and the information supplied with the lamp.

Line radiator

- Click the  icon to call up the Spectrometer window and then go to the Control tab.
- Use the [LAMP TURRET] button to open the corresponding window.

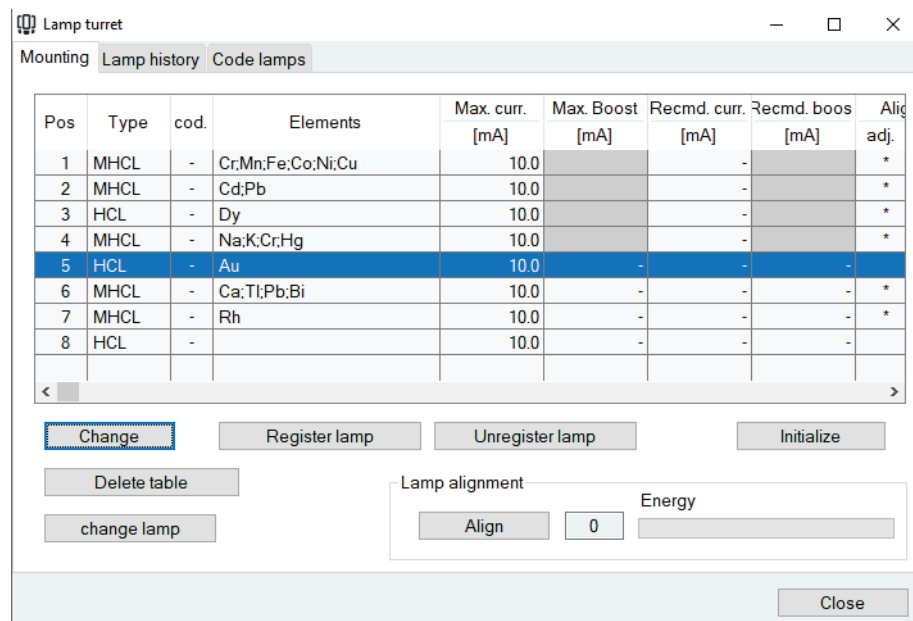



Fig. 30 Lamp turret window

- Highlight the lamp to be adjusted in the table.
- Click the [ALIGN] button.

The lamp is then automatically adjusted relative to a pitch circle. In the Lamp alignment area, the energy is displayed as a blue bar during the adjustment.

Deuterium hollow cathode lamp

1. Click on the  icon to call up the SPECTROMETER window and then go to the CONTROL tab.
2. In the BACKGROUND CORRECTION list, select the D2 BACKGROUND ONLY option.
3. Approach the spectrometer parameters using [SET].
4. Go to the ENERGY tab.

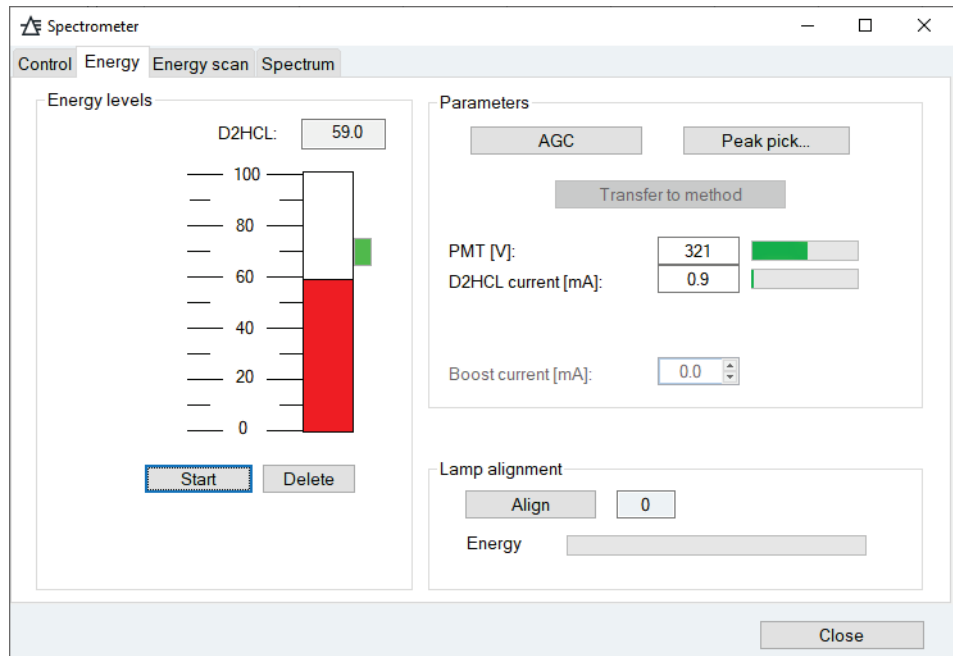

Fig. 31 Spectrometer window - Energy

5. With the [AGC] button, equalize the voltage for the photomultiplier PMT and the D2HCL current with the aim of setting the energy level to 65 to 75%.
6. With the [START] button, begin the energy measurement.
7. Set the energy level (red bar) to a maximum value:

Note: The gray highlighted bars indicate the last maximum to have been reached and can be deleted with the [DELETE] button.

 - With focus adjusting: Move the lamp holder slightly by hand in the axial direction, then tighten the locking screws.
 - With axis adjusting: Adjust the fine adjusting screws (2 in Fig. 27 p. 52).
8. Proceed, depending on possible error messages or the D2 current:
 - If an error message indicates too little energy for the D₂-HCL, first check the D2 current. If it is not at 35 mA after the control, enter the value 35 mA and repeat the control using the [AGC] button.
 - If the D2 current is already at 35 mA, increase the BC amplification by one step (steps from 0 to 4) and repeat the control using the [AGC] button.
 - If an error message indicates too much energy for the D₂-HCL (too little energy for the HCL), increase the HC amplification by one step (steps from 0 to 4) and repeat the control using the [AGC] button.

4.8 Graphite tube technique

4.8.1 Connections in the sample chamber for the graphite tube technique

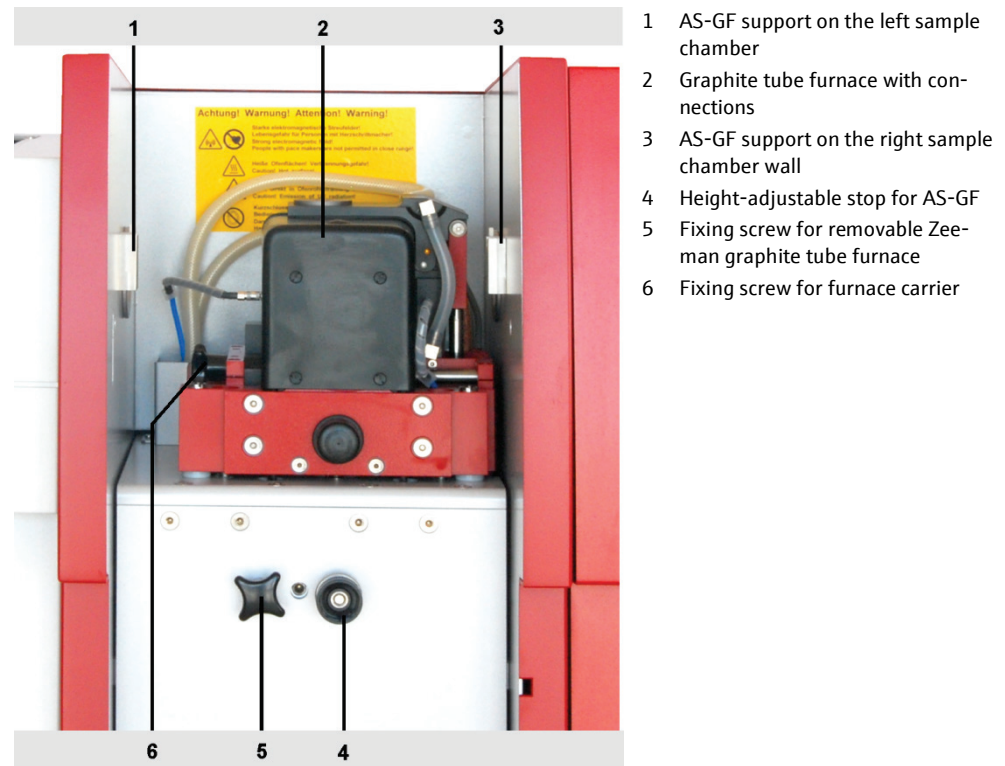

Fig. 32 Elements in the sample chamber for the graphite tube technique

The graphite tube furnace is adjusted by the manufacturer. The connections for gas and cooling water are fixed installed on the graphite tube furnace.

The ventilator for the high-current transformer is located under the furnace behind the cover.

4.8.2 Software settings for the graphite tube technique

The options for the graphite tube technique are set in the start menu of the ASpect LS software. The software interface with the method and device parameters is adjusted accordingly.

QUICK START 03.02.2021 14:40:43

Instrument: ZEEnit 700P ASpect LS Version: 1.7.0.0 **analytikjena**
An Endress+Hauser Company

OPERATOR: SuStein
LAB.: TecDoc
TECHNIQUE: Graphite furnace (Platform)

| Worksheet | Last changed | By |
|------------------------------|------------------|---------------|
| Cd in Food - GB 5009.15-2014 | 16.10.2019 10:54 | Analytik Jena |
| Mg in Food | 27.02.2020 11:45 | SuStein |
| Pb in Food - GB 5009.12-2017 | 16.10.2019 10:54 | Analytik Jena |
| Tl in Food | 16.10.2019 10:53 | Analytik Jena |

DESCRIPTION

According to GB 5009.15-2014
Sample preparation: wet-chemical digestion
Modifier: NH₄H₂PO₄ 1%
Measurement details:
Injection: 20 µL
Temperature: 600°C /1700°C
Wavelength: 228.8 nm
Calibration range: 0-2 µg/L

Favorites Recent Predefined All

Simulation

Fig. 33 Start menu of ASpect LS with settings for the graphite tube

4.8.3 Inserting the graphite tube into the graphite tube furnace

Removing and installing a graphite tube is necessary after the atomization method has been changed and after a certain number of atomizations has been carried out with the same graphite tube.



NOTICE

Never touch the graphite tube with your bare fingers! Fingerprints burn into the surface, and this causes premature damage to the pyrolysis coating of the tube.

Inserting the graphite tube into the furnace

1. Open the graphite tube furnace:

- Use the  button to open the FURNACE – CONTROL window.
- Click the [OPEN FURNACE] button.

Furnace

Furnace program ModifExtras Optimization Plot Control

Graphite furnace
Type: Platform
Heat cycles: 12
Life time: 0

Clean furnace
Temp. [°C]: 2450
Ramp [°C/s]: 500
Hold [s]: 5

Water cooler
 auto permanent

Furnace

Cooling water temp. [°C]: 30
 Furnace LED
Temperature for LED switch-off: 300

Test
 Water flow Water cooler
 Inert gas Transformer temperatur
 Add. gas

Line:

Fig. 34 Furnace window - Control

2. Clean the furnace jacket and electrodes if necessary (→ Section "Maintaining the graphite tube furnace" p. 78).
3. Insert the graphite tube (using tweezers or by hand, protected with cellulose wadding) into the graphite tube furnace so that it is loosely seated on the supports of the furnace jacket and the pipetter opening faces upwards.
There is no preferred direction for the graphite tube for solid analysis without a pipetter opening.
4. Close the graphite tube furnace with the [CLOSE FURNACE] button.
5. In the GRAPHITE FURNACE AREA enter the HEAT CYCLES and LIFE TIME parameters of the inserted graphite tube.
6. Format the graphite tube: In the GRAPHITE FURNACE area click the [FORMATION] button (→ Section "Formatting the graphite tube" p. 59).

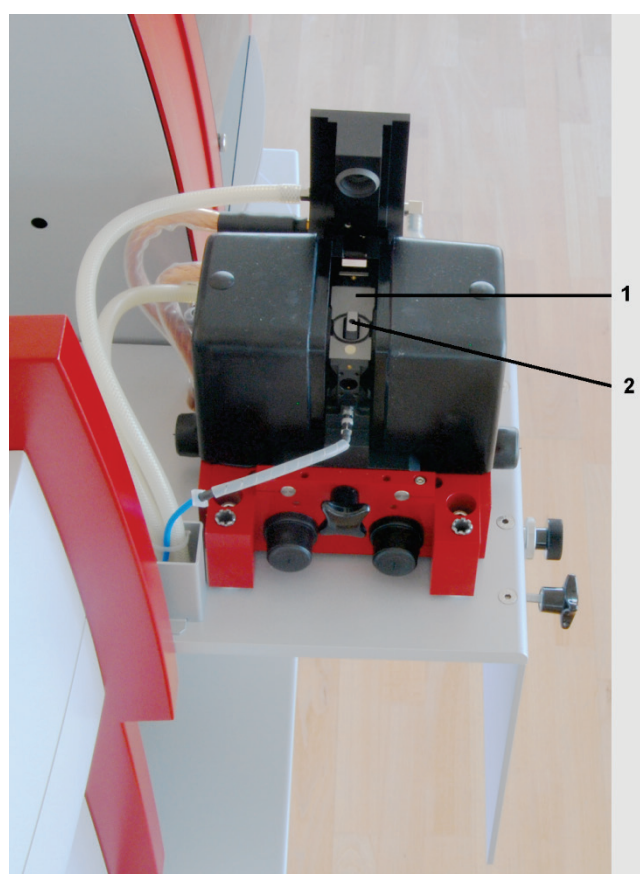

- 1 Furnace jacket
- 2 Graphite tube, inserted

Fig. 35 Graphite tube furnace opened with inserted graphite tube

Removing the graphite tube from the furnace



CAUTION

Risk of burning! Allow the graphite tube furnace to cool down before removing the graphite tube.



NOTICE

Never touch the graphite tube with your bare fingers! Fingerprints burn into the surface, and this causes premature damage to the pyrolysis coating of the tube.

1. Open the graphite tube furnace (see above).
2. Remove the graphite tube with plastic tweezers, or by hand protected with cellulose wadding.
3. Insert the new graphite tube (see above) and close the graphite tube furnace.

4.8.4 Formatting the graphite tube

When the graphite tube is formatted the following takes place

- Atmospheric oxygen is expelled from the oven and the force on the movable furnace part is adjusted
- The tube temperature is recalibrated
- The pyro coating is conditioned in the newly inserted graphite tube
- The furnace is cleaned after pausing

The furnace must be formatted after the following:

- Switching on the spectrometer
- After closing the previously opened furnace

The complete formatting program contains nine pre-programmed temperature stages.

Formatting is started in the FURNACE - CONTROL window. During formatting, the current temperature stage, time and ramp are displayed in the FORMAT TUBE window. In the first five stages, the furnace and the graphite tube are cleaned and conditioned (contacts between the graphite tube and the electrodes are aligned). By means of a special sensor technique, the tube temperature in the remaining four stages is measured. After the last temperature stage, the formatting factor for the correction of the tube temperature is displayed. The corrected furnace temperature ensures correct measurement results.

At a formatting factor of > +10 % an automatic temperature correction no longer takes place, but the current temperature-time program (TTP) can still be started after confirming the corresponding screen message. The temperature may possibly have to be manually adjusted in the furnace program.

1. Use the  button to open the FURNACE – CONTROL window (→ Fig. 34 p. 57).
2. In the FURNACE – CONTROL window enter data specific to the current graphite tube:

| | | |
|--------------------|-------------|------------------------------------|
| New graphite tube | Heat cycles | 0 |
| | Life time | 0 |
| Used graphite tube | Heat cycles | Current value of the graphite tube |
| | Life time | Current value of the graphite tube |

3. In the GRAPHITE FURNACE area click the [FORMATION] button.

4.8.5 Cleaning the graphite tube (clean out)

1. Use the  button to open the FURNACE – CONTROL window (→ Fig. 34 p. 57).
2. In the CLEAN FURNACE area set the following parameters:

| | |
|-------------|--|
| TEMP.[°C] | End temperature to be reached during clean out. The final temperature should be approx. 50 °C higher than the previous atomization temperature. |
| RAMP [°C/s] | Ramp |
| HOLD [s] | Set the hold time |

3. Start the clean out with the [START] button in the CLEAN FURNACE area. Cleaning may be repeated several times, if required at a higher temperature.

Clean out/evaporation of iridium-coated tube

The following temperature program must be used for the iridium-coated graphite tube in HydrEA technique (see also operating instructions for the accessories):

| | Clean out | Evaporation |
|-------------|-----------|--|
| TEMP.[°C] | 2200 °C | 2600 °C or more |
| RAMP [°C/s] | 500 °C/s | 500 °C/s |
| HOLD [s] | 10 s | 10 s Do not select a higher hold time, otherwise this may exceed the load limit of the furnace. |

Clean out or evaporation can be repeated several times.

4.9 Autosampler AS-GF

4.9.1 Completing and installing the autosampler



NOTICE

Switch off the ZEEnit 700 P before installing or uninstalling the AS-GF!

The connection or disconnection of electrical plug-in contacts can cause a short circuit, which destroys the device.

Choose a safe location for the completion of the AS-GF. The device can tilt easily.

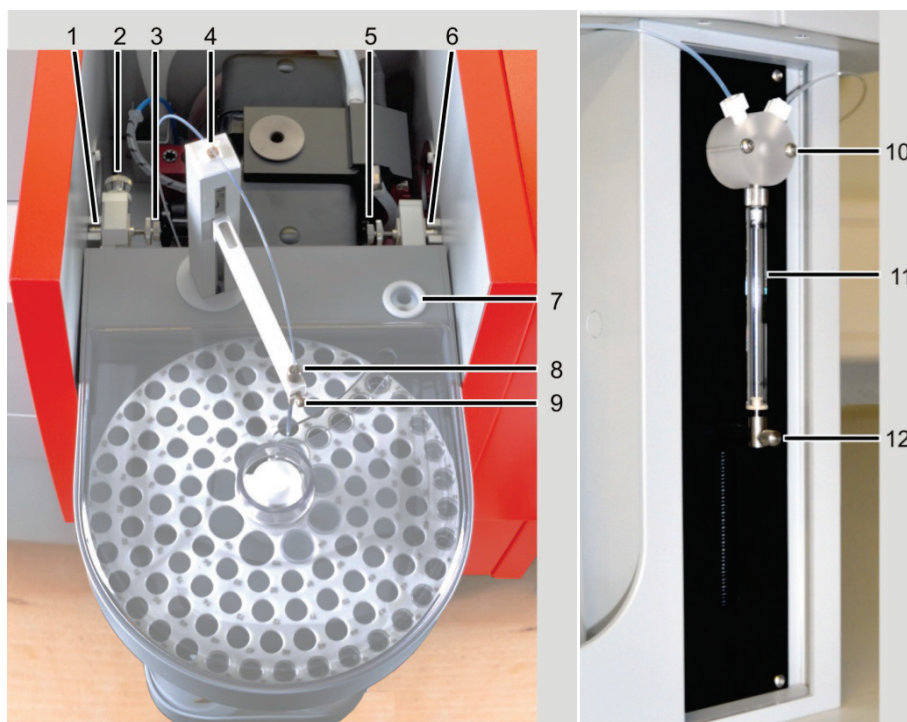

Fig. 36 Installing the AS-GF

- | | | | |
|---|--------------------------------------|----|----------------------------|
| 1 | Left support in the sample chamber | 7 | Wash cup |
| 2 | Adjusting screw 1 (for Y coordinate) | 8 | Tube guide with clamp nut |
| 3 | Adjusting screw 2 (for X coordinate) | 9 | Lock screw |
| 4 | Tube holder | 10 | T valve of the dosing unit |
| 5 | Adjusting screw 3 (for X coordinate) | 11 | Dosing syringe |
| 6 | Right support in the sample chamber | 12 | Lock screw for piston rod |

1. Install the tube guide (8 in Fig. 36) to the autosampler arm of the AS-GF and attach using the lock screw.
2. Screw the dosing tube into the right opening of the T valve (10 in Fig. 36) on the dosing unit. Feed the dosing tube through the tube holder on the back of the autosampler and on the autosampler arm. Insert the dosing tube into the tube guide (8 in Fig. 36) until the tube end protrudes approx. 8 mm from the tube guide at the bottom; attach the tube using a clamp nut.
3. Plug the control cable into the socket at the back of the AS-GF and lock it in place.
4. Hang the AS-GF on the supports in the sample chamber (1 and 3 in Fig. 32 p. 56). Using a spirit level, check whether the autosampler is suspended horizontally; if necessary, align the autosampler using the depth-adjustable stop in the sample chamber (4 in Fig. 32 p. 56).
5. If necessary, align the AS-GF with the furnace (coarse adjustment): manually rotate the autosampler arm over the dosing opening in the graphite tube. If the dosing tube does not align with the opening, the suspension of the autosampler must be moved forward or back. To this end unhook the autosampler from the sample chamber. Move the left and right suspension mounts with the aid of adjusting screw 1 and the set screw (2 and 4 in Fig. 37). Hook the autosampler back in.

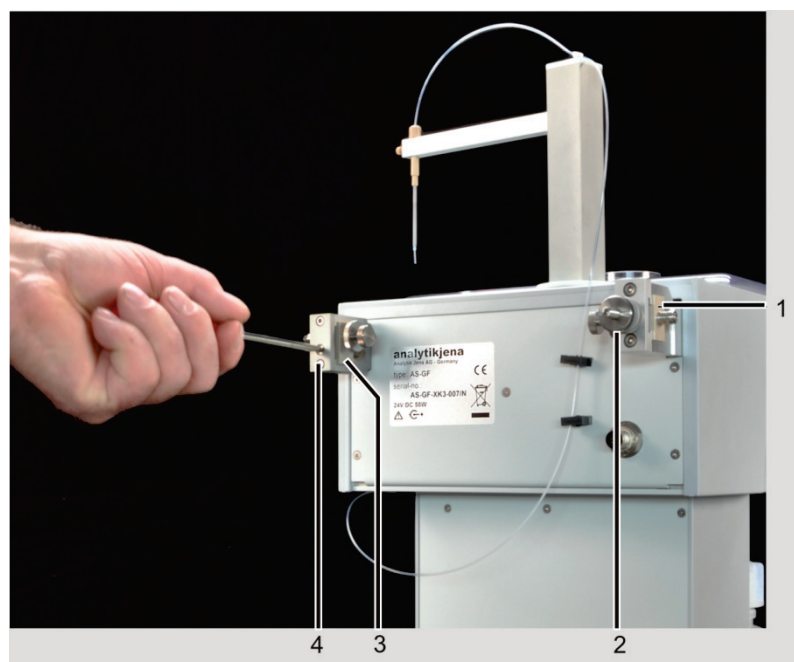

Fig. 37 Aligning the AS-GF with the furnace

- | | |
|-------------------------------------|--------------------------------------|
| 1 Slider with left suspension mount | 3 Slider with right suspension mount |
| 2 Adjusting screw 1 | 4 Adjusting screw |

6. Plug the control cable into the socket on the connection strip of the AAS device on the right side (autosampler graphite connection, 10 in Fig. 23 p. 47).
7. Place and fix the sample tray on the axis of the AS-GF.
8. Place the sample cover until it sits in the guide rail.
9. Switch on the computer and the nova 400 P, wait for the initialization steps to complete, start the ASpect LS software.
10. If necessary, fit the dosing syringe to the dosing unit (→ Section "Replacing the dosing device" p. 98).
11. Perform a fine adjustment of the autosampler (→ Section "Adjusting the AS-GF" p. 63).

Preparing the sampler for the HydrEA technique

Prior to installing the HydrEA technique the graphite tube must be coated with iridium or gold (see hydride system manual). Use the dosing tube used during graphite operation for this purpose.

1. Switch off the AAS device and install the hydride system (e.g. HS 60 modular).
2. For the HydrEA technique remove the tube guide and dosing tube from the autosampler arm of the AS-GF. Install the titan cannula to the autosampler arm and attach it using the lock screw.
3. Attach the reaction gas tube to the titan cannula.

4.9.2 Adjusting the AS-GF

The AS-GF has already been installed according to Section "Completing and installing the autosampler" p. 60 in the graphite tube furnace sample chamber. The fine alignment of the AS-GF to the furnace is supported by software. The autosampler is aligned such that samples can be optimally deposited in the graphite tube.

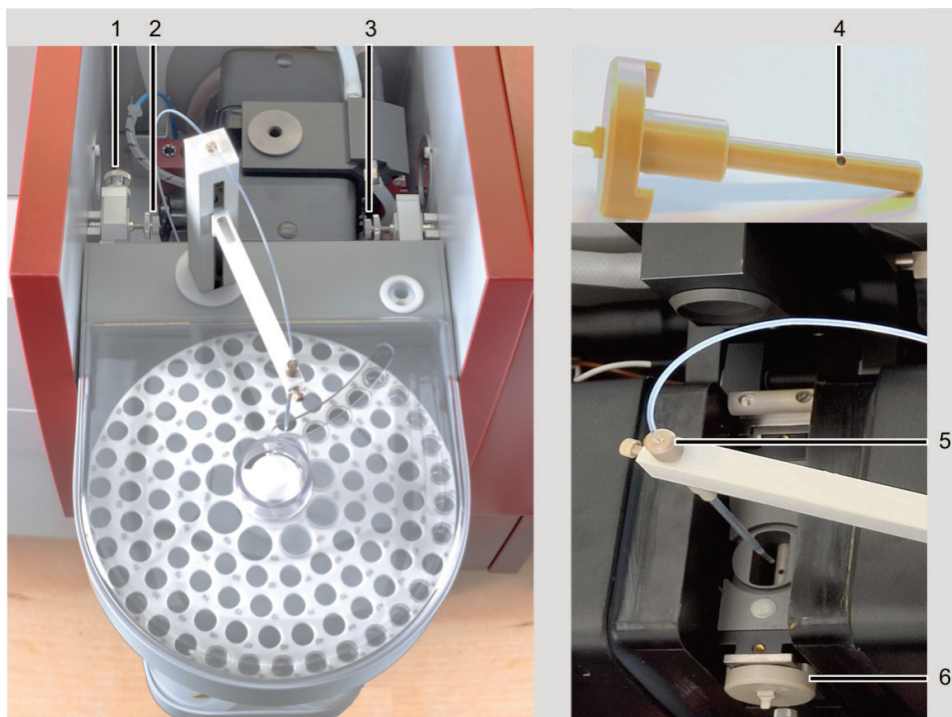



Fig. 38 AS-GF adjustment

- | | | | |
|---|---------------------------------|---|--|
| 1 | Adjusting screw 1 with lock nut | 4 | Adjusting aid |
| 2 | Adjusting screw 2 with lock nut | 5 | Tube guide with clamp nut |
| 3 | Adjusting screw 3 with lock nut | 6 | Adjusting aid in the open ZEEman furnace |

1. Start the ASpect LS software and open the AUTOSAMPLER window with the symbol , change to the tab TECHN. PARAMETERS.
2. Start the adjustment using the [ALIGN SAMPLER TO FURNACE] button.
3. Follow the prompts in the dialog fields of the software.

In the running program the following takes place:

- Alignment of the AS-GF with the furnace
- Adjustment of the dipping depth

Carry out the following work steps successively:

- Withdraw the dosing tube approx. 8 mm from the cannula of the autosampler and fix it with a clamp nut.
- Open the ZEEman furnace and insert the adjusting aid into the furnace.
- Lower the autosampler via the software to the adjusting aid.
- Align the X direction with the buttons [LEFT]/[RIGHT] to the crosshair.
- Adjust the Y direction using the adjusting screw 1.
- If required, readjust the X direction using the adjusting screws 2 and 3.

- Adjust the Z direction software-controlled:
Lower the autosampler arm up to the upper edge of the adjusting aid until the dosing tube just dips into the dosing opening.

Adjustments for X and Z direction are saved in the software.

- Secure the positions of the adjusting screws with lock nuts.
- Remove the adjusting aid and insert the dosing funnel.

Adjust the injection depth in the graphite tube:

- Lower the autosampler arm via the software. The dosing tube dips into the graphite tube.
- Loosen the clamp nut, place the dosing tube onto the tube bottom, check position with furnace camera if necessary, and fasten with clamp nut.
- Move the autosampler arm software-controlled to the optimum dispensing depth (approx. - 0.8 mm for 20 µL sample volume).

For further configurations of the autosampler see the instruction manual "ASpect LS" / section "Technical autosampler parameters".

4.9.3 Populating the sample tray of the AS-GF

1. Populate the positions of the AS-GF as follows:

| | |
|---------------------|--------------------|
| Positions 1-100 | 1.5 mL sample cups |
| Positions 101 – 108 | 5 mL special cups |

2. Place the sample cover with a tight fit.
3. Next step: fill the wash bottle. If necessary, empty the waste bottle and dispose of the waste correctly. Measure.

The population of the sample tray must match the software configuration in the method or in the sample ID.

4.9.4 Uninstalling the autosampler AS-GF

1. Switch off the ZEEnit 700 P!
2. For HydrEA coupling:
Remove the reaction gas tube from the titan cannula. Remove the titan cannula from the autosampler arm, by loosening the clamp nut.
3. Remove the control cable from the socket in the right side wall of the AAS device (autosampler graphite connection).
4. Release adjusting screw 1 and unhook the autosampler AS-GF.

4.9.5 Notes on installing the automatic solid autosampler SSA600



NOTICE

The eccentric back-up rolls must be premounted for hanging the solid autosampler SSA 600 so that they can still be rotated!

1. Use the front free hole on each side for the eccentric rolls.
2. As soon as the SSA 600 is positioned in the AS-GF mount, press the eccentric roll against the right sample chamber wall and fasten.

4.10 Flame technique

4.10.1 Connections in the sample chamber for the flame technique



Fig. 39 Connections to the burner-nebulizer system in the sample chamber

- | | |
|--|--|
| 1 Automatic ignition unit | 9 Sample liquid supply |
| 2 Burner | 10 Siphon drain tube |
| 3 Markings for alignment | 11 Connection for oxidant (blue tube) |
| 4 Stud bolt for fastening the burner | 12 Suspension AS-F / AS-FD, left |
| 5 Suspension for SFS 6 | 13 Connection for additional oxidant (black tube) |
| 6 Suspension AS-F / AS-FD, right | 14 Connection for fuel gas (red tube) |
| 7 Connecting sockets for siphon sensor, injection switch SFS 6 and scraper | 15 Fixing screw for holder bracket of burner-nebulizer system unit |
| 8 Vertical adjustment of burner-nebulizer system | |

4.10.2 Software settings for the flame technique

In the start menu of the ASpect LS software (Fig. 33 p. 57) in the TECHNIQUE group set the FLAME option. The software interface with the method and device parameters is adjusted accordingly.

4.10.3 Installation for manual sample supply

With manual sample supply the sample is loaded directly to the burner-nebulizer system. The injection switch SFS6 can be used.

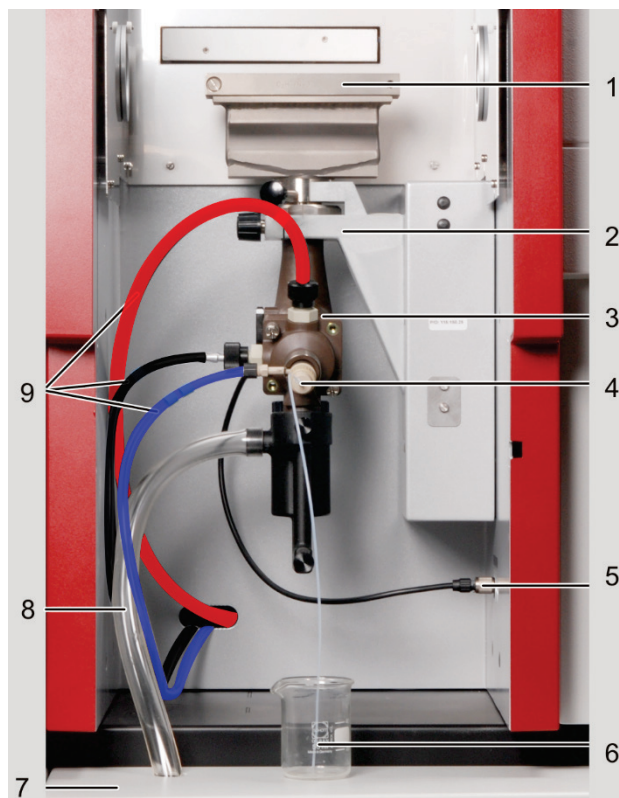

Fig. 40 Flame technique, manual sample supply

- | | |
|---|---------------------|
| 1 Burner | 6 Sample container |
| 2 Holder bracket at vertical adjustment mechanism | 7 Sample tablet |
| 3 Mixing-chamber-nebulizer system unit | 8 Siphon drain tube |
| 4 Sample aspiration tube | 9 Gas terminals |
| 5 Supply cable of siphon sensor | |



NOTICE

Switch off the ZEEnit 700 P prior to any installation! The connection or disconnection of electrical plug-in contacts can cause a short circuit, which destroys the device.

1. Remove the red protective cap from the mixing chamber tube.
2. Attach the mixing chamber-nebulizer system without burner to the holding fixture for the height adjustment. Close the holding bow and fasten with the screw.

The mixing chamber must be aligned to the height adjustment, the white marking on the connector must be above the edge of the holding fixture (3, 4 in Fig. 39 p. 65).

3. Slide the collection tray under the burner-nebulizer system in the sample chamber.
4. Hang the sample tray in the guides under the device.
5. Attach the outlet tube from the connector of the siphon through the opening in the tray to the connector of the receiving bottle.
Note: Position the outlet tube at a constant incline. If necessary shorten the tube.
6. Fill the siphon with water via the connector until water flows out via the outlet tube.
7. Connecting the gas supply:
Connect fuel gas (red tube, 14 in Fig. 39).
Connect oxidant (blue tube, 11 in Fig. 39).
Connect additional oxidant (black tube, 13 in Fig. 39).
8. Attach the required burner (50 mm or 100 mm depending on the measurement task) on the connector, turn to the stop position and clamp. Ensure that the burner is positioned correctly.
9. Plug the control cable of the siphon sensor into the m socket in the right wall of the sample chamber and screw tight.
10. Injection module SFS 6
If you are working with injection module SFS 6, install injection module (→ Section "Installing the injection module SFS 6" p. 71).
11. Place the sample and wash cups on the tray.
12. Attach the aspiration tube to the nebulizer cannula.
13. Slide the safety glass door in front of the burner.
14. Switch on the ZEEnit 700 P and start the software.

Work steps: Uninstall

1. Switch off the ZEEnit 700 P.
2. If you worked with injection module SFS 6, put injection module SFS 6 out of operation (→ Section "Installing the injection module SFS 6" p. 71).
3. Remove the sample and wash cups from the tray.

4.10.4 Installation for continuous working mode / sample supply by autosampler

In continuous working mode, the samples are loaded via the sampler AS-F or AS-FD.

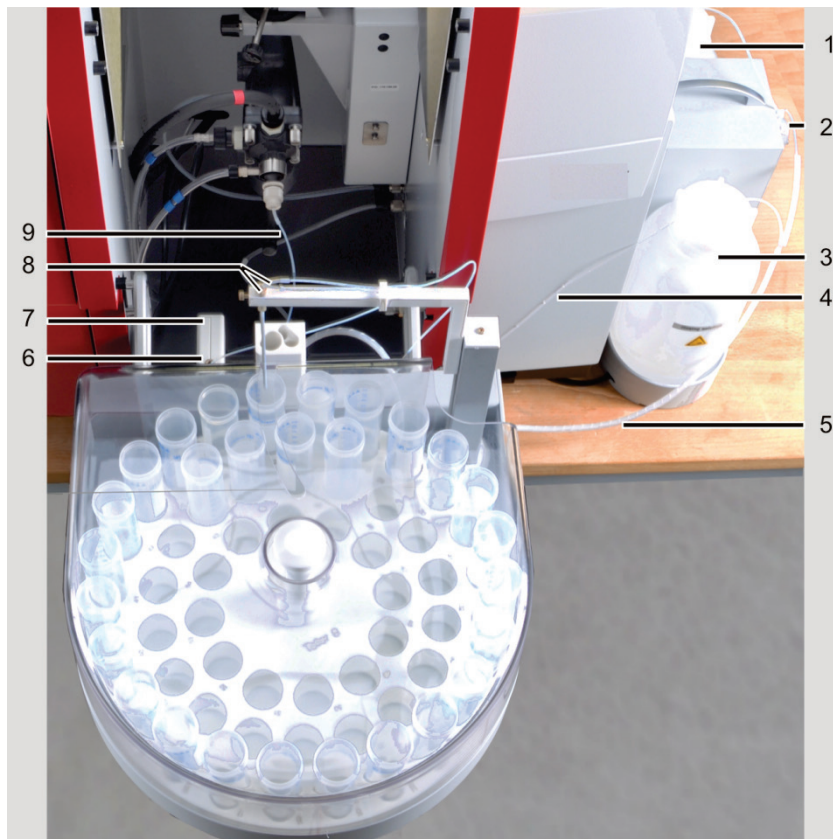

Fig. 41 Flame mode, continuous with autosamplers AS-FD and SFS 6

- | | |
|--|--|
| 1 Storage bottle for diluent | 6 Tube from autosampler arm to the SFS 6 |
| 2 Fluidics module with dosing unit | 7 Injection module SFS 6 (where applicable) |
| 3 Storage bottle for washing liquid | 8 Tube for diluent (thick cannula) and sample intake tube (thin cannula) |
| 4 Tube for washing liquid to the SFS 6 | 9 Sample intake tube |
| 5 Encased tubes for washing liquid and diluent | |



NOTICE

Switch off the ZEEnit 700 P prior to any installation! The connection or disconnection of electrical plug-in contacts can cause a short circuit, which destroys the device.

Installing the burner-
nebulizer system

1. Switch off the ZEEnit 700 P.
2. Remove the red protective cap from the mixing chamber tube.
3. Attach the mixing chamber nebulizer system without burner to the holding fixture for the height adjustment.
The mixing chamber must be aligned to the height adjustment, the white marking on the connector must be above the edge of the holding fixture (3, 4 in Fig. 39 p. 65).
4. Slide the collection tray under the burner/nebulizer system in the sample chamber.
5. Plug the outlet tube from the connector of the siphon to the connector or the corresponding opening in the lid of the collection bottle.
Note: Position the outlet tube at a constant incline. If necessary shorten the tube. Tube must not dip in the liquid.

6. Fill the siphon with water via the mixing chamber tube until water flows out via the outlet tube.
7. Plug the connector of the siphon sensor to the connection on the right sample chamber wall (7 in Fig. 39 p. 65).
8. Connecting the gas supply:
Connect fuel gas (red tube, 14 in Fig. 39).
Connect oxidant (blue tube, 11 in Fig. 39).
Connect additional oxidant (black tube, 13 in Fig. 39).
9. Attach the required burner (50 mm or 100 mm depending on the measurement task) on the connector, turn to the stop position and clamp. Ensure that the burner is positioned correctly.

Installing the injection module

If you are working with injection module SFS 6, install injection module SFS 6 (→Section "Installing the injection module SFS 6" p. 71).

Installing the sampler

1. Hang the autosampler in the corresponding supports of the sample chamber (6 and 12 in Fig. 39 p. 65). Adjust the adjusting screw at the right suspension mount in such a way that the autosampler cannot slip out of the mounting hole (3 in Fig. 42 p. 70).
2. Place the Fluidics module (for AS-FD) or storage bottle for washing liquid (for AS-F) next to the AAS device.
3. Plug the control cables for connecting the autosampler to the Fluidics module and the AAS device into the connections on the rear of the autosampler and lock them in place (1 and 2 in Fig. 42).
4. Plug the control cable into "Sampler flame" connection on the right-hand wall of the ZEEnit 700 P (1 in Fig. 23 p. 47) and lock it in place.
5. Attach the outlet tube to the outlet connector of the autosampler (back plate, 4 in Fig. 42). Attach the outlet tube to the connector or the corresponding opening in the lid of the collection bottle.
Note: Position the outlet tube at a constant incline. If necessary shorten the tube. Tube must not dip in the liquid.
6. Screw the tube for the washing liquid to the rear of the autosampler (5 in Fig. 42).
Note: In the AS-FD the tubes for connecting the autosampler and the Fluidics module are attached to each other by encasing and are numbered. The tubes are attached to the rear of the autosampler using the attachment lug. Marking Wash tube "2".
7. In the AS-FD feed the dosing tube for the diluent (marking "1") through the tube guide at the autosampler arm and plug it onto the thicker cannula of the autosampler arm.
Note: The autosampler arm can be moved manually when switched off.
8. Attach the sample intake tube to the nebulizer.
9. Plug the sample intake tube through the tube guide at the autosampler arm onto the thin cannula of the autosampler arm.
10. Place the sample tray onto the autosampler housing, make sure it latches.

Note: The controller does not start the autosampler or stops automatically if no sample tray has been placed.

11. Place the sample cover until it sits in the guide rail.



- 1 Fluidics module connection
- 2 AAS connection
- 3 Suspension mount with adjusting screw
- 4 Connector for outlet tube
- 5 Screw for wash tube

Fig. 42 Rear of the autosampler AS-FD

Preparing the Fluidics module (for AS-FD)



- 1 Storage bottle for washing liquid
- 2 Diluent connection
- 3 Dosing tube connection (to AS-FD)
- 4 Dosing syringe, consisting of piston and glass cylinder
- 5 Dosing syringe with attachment screw
- 6 Storage bottle for diluent

Fig. 43 Dosing unit at the Fluidics module of the AS-FD

1. If necessary, fit the dosing syringe to the dosing unit (→ Section "Replacing the dosing device" p. 98).
2. Place the storage bottles for the wash liquid (left) and diluent (right) into the bottle holders of the Fluidics module.
3. Immerse the short tube (marking at the tube "3") into the storage bottle for the diluent. Screw the second tube end to the valve (2 in Fig. 43).
4. Screw the dosing tube for the diluent (encased, marking "1") to the second connection of the valve (3 in Fig. 43).
5. Immerse the hose for the wash liquid (marking "2") into the storage bottle.

- Uninstalling the sampler
1. Switch off the ZEEnit 700 P.
 2. Detach the sample intake tube from the thin cannula of the autosampler arm.
 3. Detach the tube for the wash liquid at the rear of the autosampler.
 4. For the AS-FD detach the dosing tube for the diluent from the thicker cannula. Pull the two encased tubes out of the attachment lug at the rear of the autosampler.
 5. Pull the outlet tube from the connector of the autosampler (back plate).
 6. Detach both control cables at the rear of the autosampler.
 7. Take the autosampler out of the sample chamber.
- Uninstalling the injection module
- If the injection module SFS 6 was used during operation, decommission the injection module SFS 6 (→Section "Installing the injection module SFS 6" p. 71).

4.10.5 Installing the injection module SFS 6

Installing the SFS 6



Fig. 44 SFS 6 installed for manual sample supply to the ZEEnit 700 P

- | | |
|---|---------------------------------------|
| 1 Tube connecting to sample/autosampler | 3 Communication cable to controller |
| 2 Tube connecting to nebulizer | 4 Tube connecting to rinsing solution |
1. Screw the aspiration tubes into the free connections of the injection module:
Short piece of tube in the middle connection – to the nebulizer
Long piece of tube in the upper connection – to the wash solution/carrier solution
Middle piece of tube in the lower connection – to the autosampler/sample.
 2. Hang the injection module on the hanging mount at the front of the height adjusting unit.
 3. In the basic setting (not powered), the tube for carrier solution is released for flow.

4. Plug the control cable into the middle two-pole connector socket in the right wall of the sample chamber and screw tight.
5. Stick the short piece of tube onto the nebulizer cannula.
6. Dip the tube for carrier solution (long tube) into the supply bottle.
7. Dip the sample tube (medium length tube) into the sample cup or connect with the aspirating cannula of the autosampler.

Put injection module
SFS 6 out of operation

1. Remove the intake tubes out from the washing liquid bottle and the sample cup (for manual operation), or pull them off the intake cannula of the autosampler, allowing the system to drain.
2. Pull off the short piece of tube from the nebulizer cannula.
3. Detach the control cable of the SFS 6 from the AAS, remove the injection module.

4.10.6 Installing the scraper at a later stage

When working with the nitrous oxide flame it is recommended to use a scraper. Alternatively, carbon deposits can be manually removed from the burner slot with the scraper. The scraper is delivered ready installed on the 50 mm burner upon request. It can also be retrofitted to a 50 mm burner.

The scraper is delivered ready installed on the 50 mm burner by the manufacturer upon request. It can also be retrofitted on a 50 mm burner.



BEACHTE

For combustion gas flows > 250 NL/h pay attention to stubborn deposits. Remove these where necessary to ensure the functionality of the scraper.

1. Unscrew the screws from the front burner jaw (arrow in Fig. 45) (the screw for fastening the burner on the connector of the mixing chamber is also located on the side of the front burner jaw).
2. Unscrew the fastening rail (1 in Fig. 46) with knurled screws (2 in Fig. 46) from the scraper.
The captive knurled screws remain attached in their holder in the scraper.
3. Mount the fastening rail on the burner body. Use the long titan screws and nuts. Place the screws through the front burner jaw and screw down the fastening rail with nuts.
4. Attach the scraper to the guide pins of the fastening rail (2 in Fig. 46) and tighten with knurled screws (3 in Fig. 46).

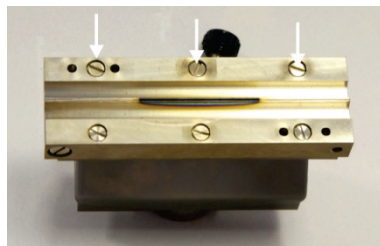

Fig. 45 Screws on the front burner jaw

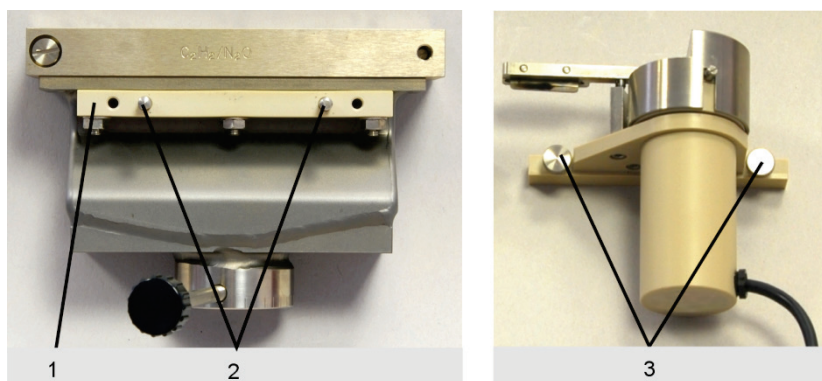

Fig. 46 Fastening rail mounted on burner/knurled screws on the scraper

- | | | | |
|---|--------------------------------|---|----------------|
| 1 | Fastening rail for the scraper | 3 | Knurled screws |
| 2 | Guide pins | | |

4.10.7 Replacing the burner



CAUTION

Risk of burning! To remove the hot burner, use the burner bracket (optional accessory). Otherwise wait until the burner has cooled down.

1. Push the sample chamber door upwards.
2. Loosen the fixing screw of the burner and take the burner off. Use the burner bracket if available.
3. Place the new burner on the connector of the mixing chamber, turn against the stop 0° and fasten with the fixing screw.

4.11 Starting up the ZEEnit 700 P with accessories

4.11.1 Switching on sequence, daily work commencement

1. Switch on the PC and wait for the computer program to initialize: The user icons appear on the screen, including the ASpect LS program icon.
2. Switch on the ZEEnit 700 P: Press the green ON/OFF switch on the right side wall.
3. Start the ASpect LS program: Double-click with the mouse cursor on the ASpect LS symbol.
4. Connect the printer and the compressor if they are needed.

The AAS system is now switched on, work (analysis preparation and measurement) may begin.



NOTICE

The mobile cooling unit KM5 is controlled by the ZEEnit 700 and is therefore not switched on manually.

4.11.2 Switching off sequence

1. On the PC close the application program Aspect LS: Click the FILE ► CLOSE menu options.
2. For unsaved values decide whether unsaved data/information should be saved before exiting the program.
3. Shut down the PC.
4. Use the respective mains switches to switch off (in this order):
 - Compressor
 - AAS accessories
 - AAS
 - Printer
 - PC

The AAS system is now switched off.

5 Service and maintenance



WARNING

Electric shock! The ZEEnit 700 P must be switched off before carrying out any maintenance work. Pull the mains plug. The safe disconnection of the ZEEnit 700 P from the mains can only be achieved by pulling the mains plug. Power is still supplied to both certain areas of the spectrometer, as well as the output socket, after the device has been switched off at the main switch.

The only exception to this are maintenance tasks that must be carried out while the AAS device and the control software are running, such as the baking out of the graphite tube.



WARNING

Risk of skin and eye damage caused by UV radiation!

HCL, D₂-HCL, the heated graphite tube ($T > 1000\text{ °C}$) and the flame of the burner transmit radiation in the UV range. Do not look into the rays emitted by the lamp, the graphite tube or the flame without UV protection goggles. Protect the skin against radiation.

Switch off the lamp by means of the control and analysis software ASpect LS before opening the lamp door: To do so, open the section OPTICAL PARAMETERS in the SPECTROMETER / CONTROL window of the ASpect LS software and set the lamp current [mA] to zero. Open the drop-down list BACKGROUND CORRECTION and select the option NO BACKGROUND. Click [SET]. Negate the error message.

To observe the placement of the samples or the drying of liquid samples, the dental mirror may only be inserted into the beam path from the left side of the graphite furnace. When observing on the right side of the furnace, UV radiation may be reflected.



WARNING

The operator is responsible for ensuring the proper decontamination of the device before maintenance and repair works. This applies to any case in which the inside or the outside of the device have been contaminated with hazardous substances.



CAUTION

The operator must not undertake any service or maintenance work to this device and its components other than those specified and described in this chapter.

Please observe the notes in section "Safety instructions" on page 9. Compliance with the safety instructions is a prerequisite for the error-free operation of the device. Always observe all warnings and instructions that are displayed on the device itself or indicated by the control and analysis software ASpect LS.

To guarantee faultless and safe functioning, the ZEEnit 700 P should be inspected on an annual basis by the Analytik Jena service department.



CAUTION

Risk of burns from touching hot surfaces! Observe the required cooling times before starting any maintenance tasks on the graphite furnace and the burner-nebulizer system.

5.1 Maintenance overview

Table 8 Maintenance overview

| Maintenance item | Action | Frequency |
|---|---|--|
| Base device | | |
| Fuse | Change the fuse | When required |
| Sample chambers | Clean sublimated substances (residues) | Regularly |
| | Remove residual liquid from the tray | If there are residues in the tray |
| | Clean the windows for beam entry and -exit in the sample chamber | On visual inspection: Streaks, burnt-in residues; when energy losses arise |
| Graphite tube furnace | | |
| Graphite tube | Clean by cleaning out (heating up) using the cleaning program of the ASpect LS software | Daily |
| Iridium-coated graphite tube | Evaporation of iridium coating | After approx. 500 atomizations or for a new coating (Malfunctions result in falsified measurement results) |
| Furnace window | Wipe with a lint-free cloth soaked in alcohol To remove stubborn contamination, use a mild surfactant. | Weekly |
| Graphite electrodes | Clean the contact surfaces of the electrodes with a cotton swab, a lint-free cloth soaked in alcohol, or blotting paper | Regularly |
| | Check for wear, replace if necessary. | Every six months |
| Pipetter insert | Clean and wash | May be necessary on a daily basis, depending on the type of samples |
| Autosampler AS-GF/AS-F and AS-FD | | |
| Dosing tube/cannulas | Check for freedom from deposits, kinks and cracks. | Check regularly since sediments can falsify the measurement results |
| Wash cup, mixing cup | Clean | Regularly |
| Gas connectors | | |
| | Check for leaks | When connections are newly connected and when a clear pressure loss is detected by the manometer. |
| Burner-nebulizer system | | |
| | Dismantle and clean | Depending on the analyzed sample material (medical samples or samples with a high salt content) |
| Mobile cooling unit KM5 | | |
| Water container | Check the water level in the water container and fill up with softened water | After emptying, otherwise quarterly |
| Cooling fins | Keep clean | Permanently |

| Piston compressor | | |
|--|------------------------------|-------------------|
| Pressure cylinder, fluid separator on the pressure reducer | Drain condensation water. | Weekly. |
| Suction filter | Check. | Monthly. |
| | Clean, replace if necessary. | Every six months. |
| Oil | Check the oil level. | Weekly. |
| | Change the oil. | Annually |

5.2 Base device

5.2.1 Replacing the fuses



WARNING

Risk of electric shock!

Prior to replacing the fuses always switch off the device with the mains switch and pull the plug. The power supply fuses (F1, F2) and the internal fuse for the power supply of the magnet (F1 internal MagPS) may only be replaced by Analytik Jena service engineers or by technical personnel authorized by Analytik Jena.

The fuses of the ZEEnit 700 P are to be found on the rear side of the device. They are marked.

Fuses on the rear
(see Fig. 24)

Table 9 Fuses on the rear

| Fuse number | Type | Protected circuit |
|-------------------|-------------|---|
| F1 | 32 A/T | Power supply |
| F2 | 32 A/T | Power supply |
| F3 | T 6.3 A/H | Socket for external accessories |
| F4 | T 6.3 A/H | Socket for external accessories |
| F5 | T 2.5 A/H | Transformer, primary side, NTL |
| F6 | T 2.5 A/H | Transformer, primary side, NTL |
| F7 | T 6.3 A/H | Power supply of the magnet |
| F8 | T 6.3 A/H | Power supply of the magnet |
| F9 | T 0.08 A | D2-HCL |
| F10 | T 0.25 A | HCLs |
| F11 | T 0.08 A | Boost current |
| F12 | T 1 A | Heating for boost current |
| F13 | T 0.032 A | Analog |
| F14 | T 3.15 A | Filament |
| F1 internal | TR5-T100 mA | Zeeman graphite tube furnace measuring lead |
| F1 internal MagPS | FF 4 A/H | Power supply of the magnet |

The fuse F1 internal for the Zeeman furnace measuring lead is located easily accessible in the rear of the base of the furnace.

If fuse F1 internal MagPS has melted, the ASpect LS software indicates an error with the magnet control. The software specifies which fuses are to be checked.

5.2.2 Cleaning of sample chambers

1. Clean the sample chambers regularly with a lint-free cloth moistened with alcohol.
2. If there are liquid residues in the sample chamber tray, e.g., from the siphon outlet, pull out, empty then wipe out the sample chamber sump with a dry cloth.
3. Check the radiation entrance and exit windows of the sample chambers if energy losses are detected:

Wipe the windows free of streaks with a lint-free cloth soaked in alcohol (optical cloth).

5.3 Graphite tube furnace

5.3.1 Maintaining the graphite tube furnace

After a prolonged operation time, sample residues, modifiers and sublimated carbon particles of the graphite tube are deposited on the contact surfaces of the graphite electrodes, the furnace jacket, the radiation sensor (radiation requires free passage from the graphite tube through the furnace jacket and lower electrode to the sensor) and the pipetter inset. These deposits can be a source of contamination and can lead to increased deviations of the formatting factor. Damaged furnace parts (furnace jacket, graphite tube, electrodes) can be the cause of substandard analysis results.



CAUTION

Risk of burning at the hot furnace!

Allow the graphite tube furnace to cool down before attempting any service or maintenance work.

Cleaning the furnace windows:



NOTICE

Do not touch the quartz panes of the furnace windows with your bare hands. Fingerprints burn in.

Do not clean the furnace windows in an ultrasonic bath. This may lower the UV permeability of the windows.

Danger of embrittlement of the rubber seals. When cleaning the furnace windows with a cloth soaked in alcohol, make sure that the rubber seals do not come in contact with the alcohol!

1. Allow the furnace to cool down.
2. Open the furnace and take both furnace windows out of their guide. (The left furnace window can also be removed when the furnace is closed.)
3. Wipe the furnace window with a lint-free cloth soaked in alcohol. To remove stubborn contamination, use a mild surfactant.
4. Replace the furnace windows in their guides, taking care not to damage the sealing rings.

Cleaning the graphite surfaces

The graphite surfaces must be cleaned after each daily use as required.

1. Switch on the ZEEnit 700 P, start the ASpect LS software and open the furnace via the software (the movable furnace part must be pressurized to be opened/closed):
 - Use the  button to open the FURNACE window. Go to the CONTROL tab.
 - Open the furnace with the [OPEN FURNACE] button.
2. Remove the pipetter insert from the furnace jacket and clean it in 0.1 - 1 N HNO₃. Then wash thoroughly with slightly acidic or demineralized water.
3. Clean the contact surfaces of the electrodes with a cotton swab, a lint-free cloth soaked in alcohol, or blotting paper.
4. Clean the inner surfaces of the furnace jacket with a cotton swab.

5.3.2 Separation of the graphite tube furnace from the Zeeman magnet and reinsertion

To replace the electrodes and furnace jacket, the graphite tube furnace must be extracted from the sample chamber and the furnace parts separated from the magnet.

Separation

1. Loosen the locking screw (cross-head screw, 7 in Fig. 47) for the graphite tube furnace.

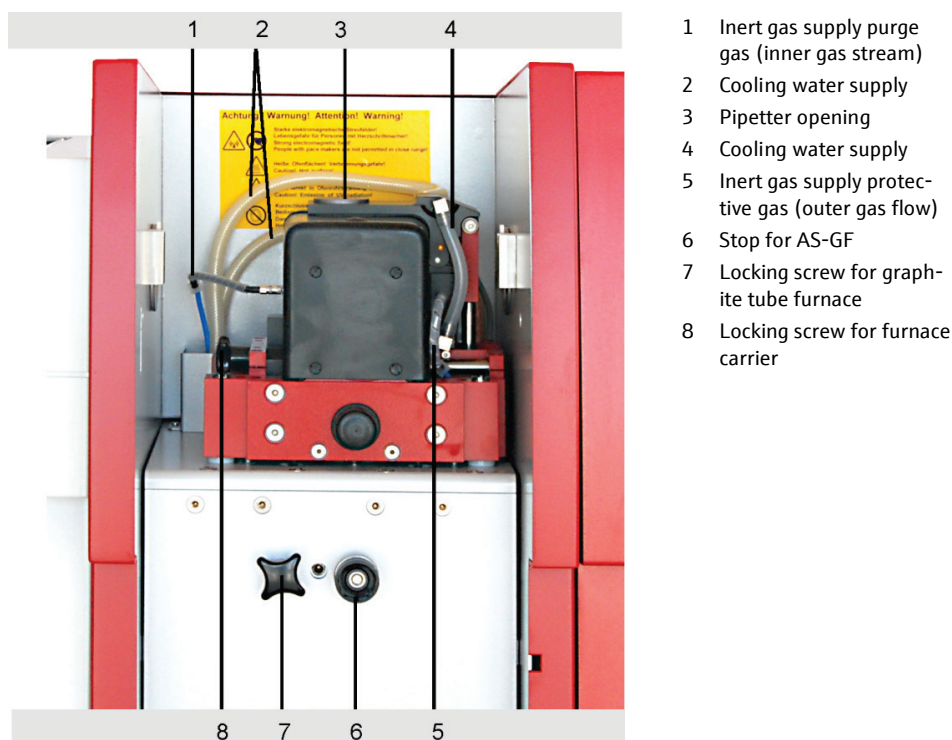

Fig. 47 Locking screws for the graphite tube furnace



NOTICE

Danger of collision! The furnace may not be opened during the following work step!

2. Pull the graphite tube furnace out of the sample chamber to the end stop.
3. Pull out the left furnace window (2 in Fig. 49) upwards and pull off the gas tube (1 in Fig. 49) from the connector below the furnace window.

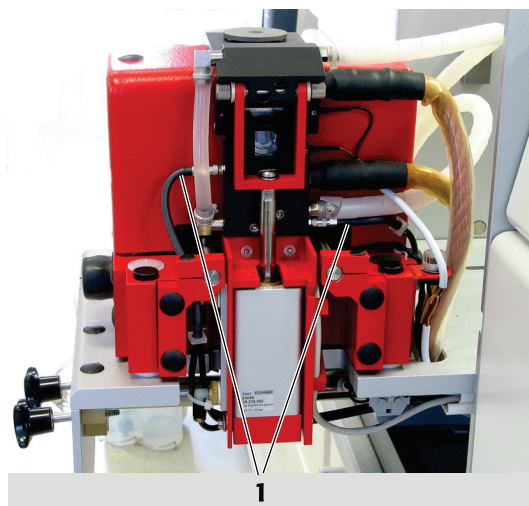

Fig. 48 Driven-out furnace, right side

4. Pull off both tubes on the right of the furnace.
5. Remove the pipetter insert (3 in Fig. 49) from the swiveling part of the furnace.

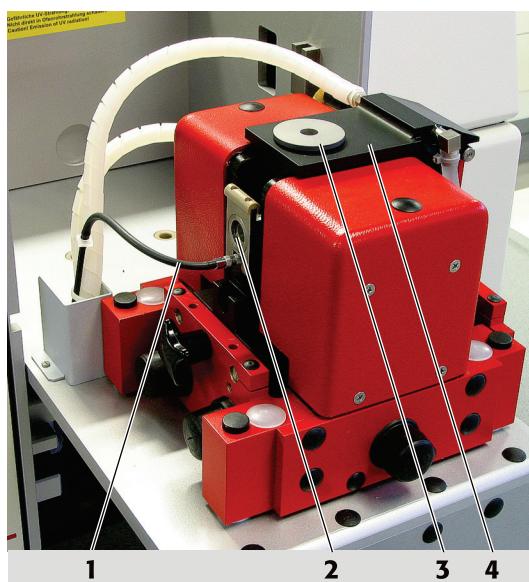
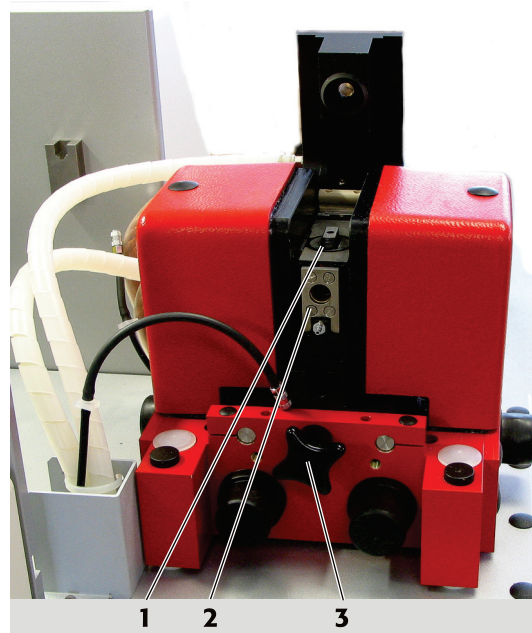

Fig. 49 Driven-out furnace

6. Using ASpect LS, open the graphite tube furnace with the [OPEN FURNACE] button in FURNACE – CONTROL window.
7. Take out the graphite tube.



- 1 Graphite tube
- 2 Sealing plate for left furnace window
- 3 Cross-head screw, furnace carrier

Fig. 50 Driven-out furnace, open, left side

8. Unscrew the sealing plate (2 in Fig. 50) for the left furnace window (4 titan slot-headed-head screws).
9. Loosen the cross-head screw (3 in Fig. 50) to the left of the furnace carrier.
10. Press the furnace carrier carefully by hand to the right out of the fixed magnets.

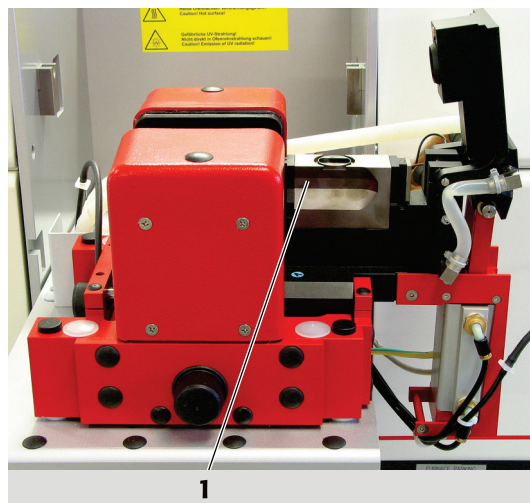

- 1 Furnace jacket

Fig. 51 Driven-out furnace carrier

The furnace is now ready for maintenance work, furnace jacket and electrodes are easily accessible. Once the maintenance is complete, bring the furnace back to its original position:

Bring the furnace to the working position

1. Press the furnace carrier by hand back between the pole shoes (2 in Fig. 52) of the Zeeman magnet.
2. Screw the furnace carrier finger tight with the cross-head screw (3 in Fig. 50).

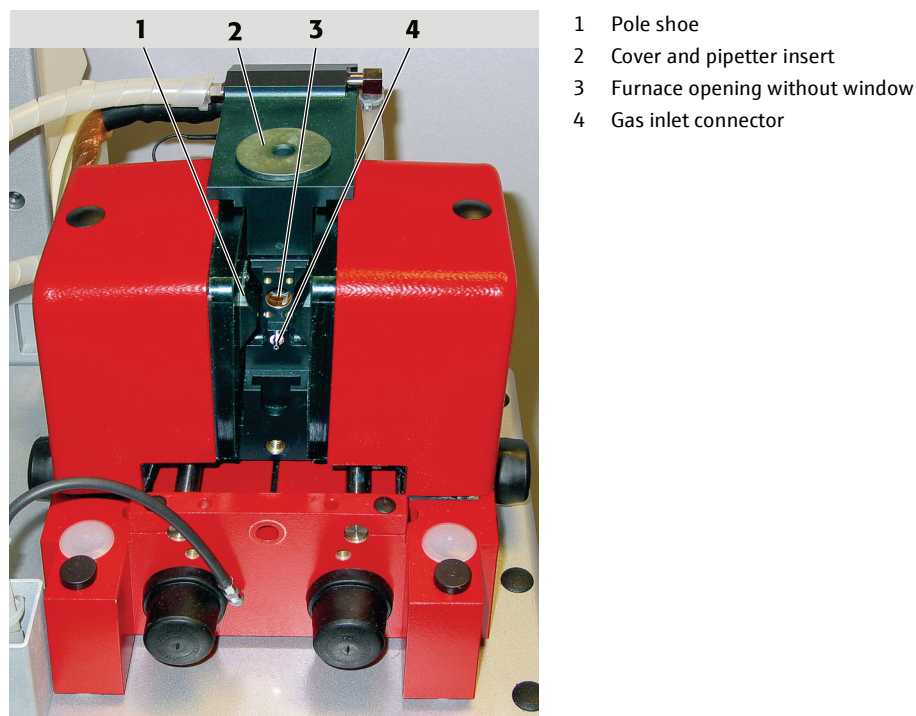

Fig. 52 Furnace partially pressed out of the Zeeman magnet

3. Screw on the sealing plate for the left furnace window.
4. Attach the gas tube onto the connector (4 in Fig. 52) below the furnace window (quick connector).
5. Attach both gas tubes onto the right side of the furnace (Fig. 48).
6. Set the left furnace window into the guide on the furnace.
7. Slide the graphite tube furnace into the sample chamber as far as the end stop and lock in place.

5.3.3 Removing and cleaning the temperature sensor group

The temperature sensor must be removed before changing the electrodes. The sensor for temperature recalibration is mounted from below in the bottom furnace part. The temperature sensor senses the radiation through the openings in the furnace jacket and in the lower electrode directly from the graphite tube.

1. Loosen the two knurled screws (1 in Fig. 53) at the bottom of the furnace.
2. Pull the sensor group (2 in Fig. 53) out of the holder. Make sure that the sealing ring on the sensor is not lost.
3. Clean the front of the radiation sensor with a lint-free cloth soaked in alcohol.

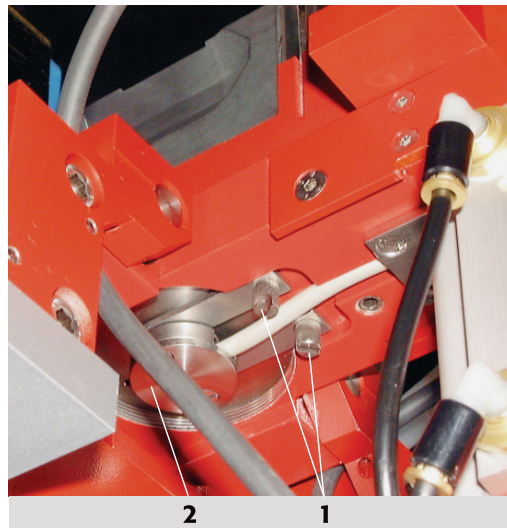

- 1 Knurled screws
- 2 Sensor group

Fig. 53 View of the furnace with radiation sensor module from below

At this point, change the lower electrode and the furnace jacket if necessary, then replace the sensor group in reverse order. Make sure that the sealing ring is inserted. Tighten the knurled screws only finger tight.

5.3.4 Replacing the upper electrode

The electrodes must always be replaced in pairs, either as required or if there is a formation error >10 also after cleaning the electrodes and changing the graphite tube. The furnace tools are not included in scope of supply and can be ordered as an option. The electrodes can also be changed by service engineers.

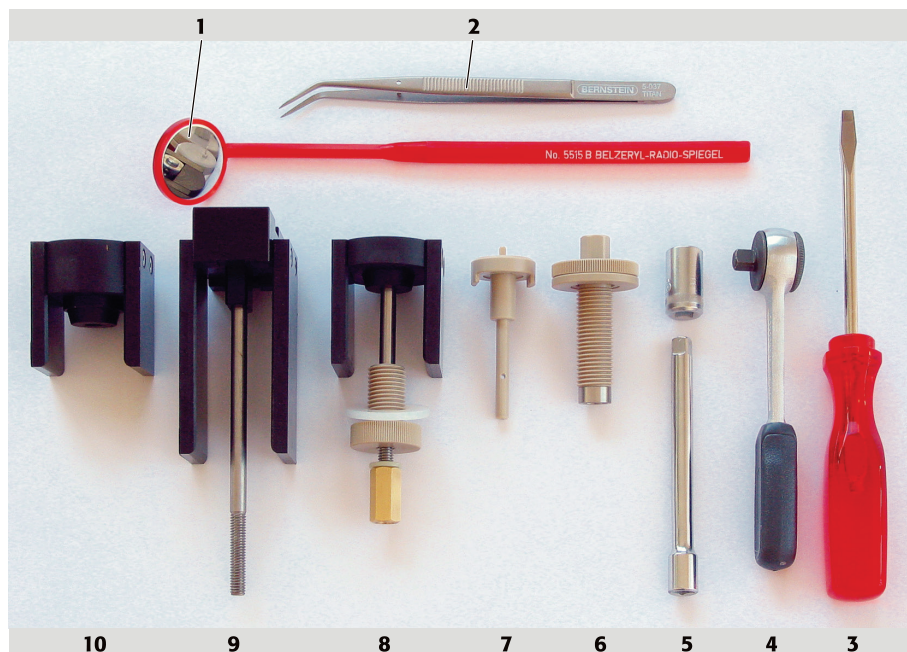

Fig. 54 Furnace tools

- 1 Dental mirror
- 2 Tweezers
- 3 Screwdriver
- 4 Ratchet wrench for hexagonal bit
- 5 Hexagonal bit and extension
- 6 Press-out tool for electrodes and furnace jacket
- 7 Graphite tube adjusting aid
- 8 Pressure piece for lower electrode with short spindle, flange nut and spindle nut
- 9 Pressure piece for furnace jacket with longer spindle
- 10 Pressure piece for upper electrode

1. Press out the upper electrode with the press-out tool:

Screw the press-out tool (6 in Fig. 54) as far as the stop in the furnace jaw using a ratchet wrench (4 in Fig. 54). Keep carefully rotating the press-out tool in until the electrode falls out of the electrode holder. Unscrew the press-out tool from the jaw.

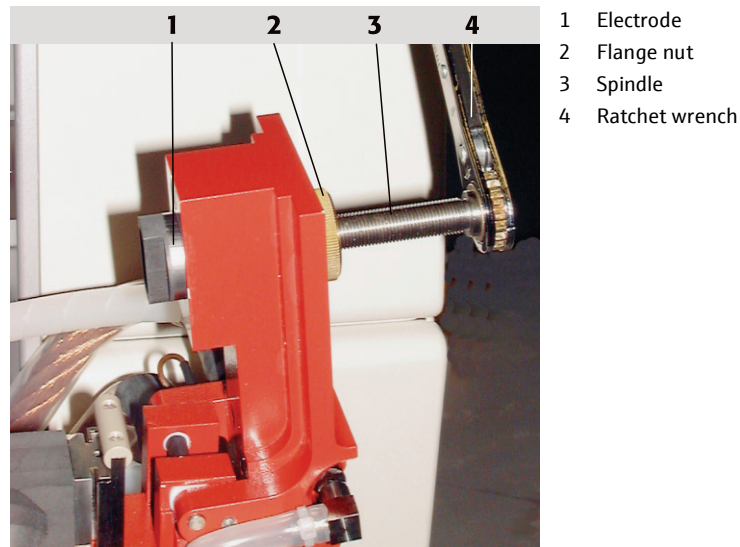

Fig. 55 Electrode, partially pushed out

2. Screw in the flange nut (3 in Fig. 56) of the insertion tool as far as the stop in the furnace jaw.



NOTICE

Risk of destroying the electrode. Make sure that the electrode and the furnace jaws are parallel when positioning and inserting the electrode. If the electrode is unintentionally skewed, remove completely and start again.

3. Insert the shorter spindle into the pressure piece "upper electrode". Lead a new electrode over the spindle. Lead the pressure piece "upper electrode" with spindle and electrode into the furnace jaw, slide the pressure piece over the furnace jaw and align the electrode. Screw the spindle nut with washer by hand onto the free spindle end as far as the stop. Insert the electrode into the jaws as far as the fixed front rest, using the spindle nut and the ratchet wrench.

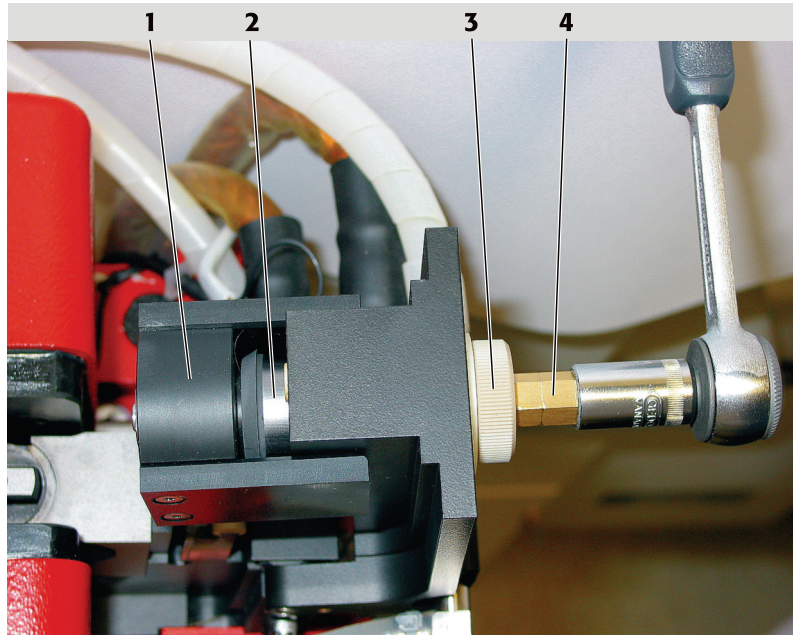

Fig. 56 Electrode with insertion device, mounted on the jaw

- | | | | |
|---|----------------|---|-------------|
| 1 | Pressure piece | 3 | Flange nut |
| 2 | Electrode | 4 | Spindle nut |

4. Unscrew and remove the spindle nut completely, to do so hold the pressure piece with your left hand and pull out. Unscrew the flange nut.
5. Remove by suction or blow away any graphite dust which is present.

5.3.5 Replacing the graphite tube jacket and the lower electrode

The graphite tube jacket and the lower electrode have to be replaced:

- When damaged
- When contamination cannot be removed by cleaning
- If the formation factor of >10 % remains after cleaning the electrode and changing the graphite tube.

The electrodes must always be replaced in pairs!

1. Separate the graphite tube furnace from the Zeeman magnets (→ Section "Separation of the graphite tube furnace from the Zeeman magnet and reinsertion" p. 79).
2. Remove the temperature sensor group (→ Section "Removing and cleaning the temperature sensor group" p. 82)
3. Screw in the press-out tool (6 in Fig. 54) in place of the removed temperature sensor as far as the stop.

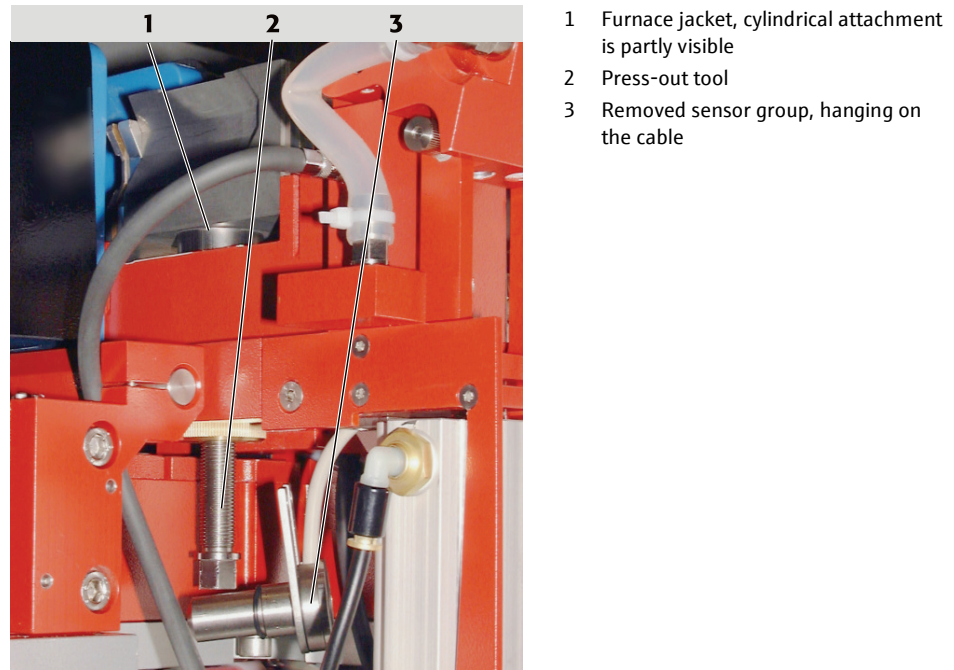

Fig. 57 Furnace jacket, partly pressed out

4. Turn the spindle of the press-out tool with the ratchet wrench. Guide the furnace jacket with your hand. Take out the furnace jacket and the lower electrode.
5. Unscrew the press-out tool from the furnace and then screw in the flange nut of the insertion tool in the same position as far as the stop.
6. Insert the shorter spindle into the pressure piece "lower electrode".
7. Attach a new lower electrode onto the spindle. Guide the pressure piece "lower electrode" with spindle and electrode into the furnace carrier, sliding the pressure piece over the furnace carrier and lining up the electrode with the opening.
8. Screw the spindle nut with washer onto the free spindle end as far as the stop.

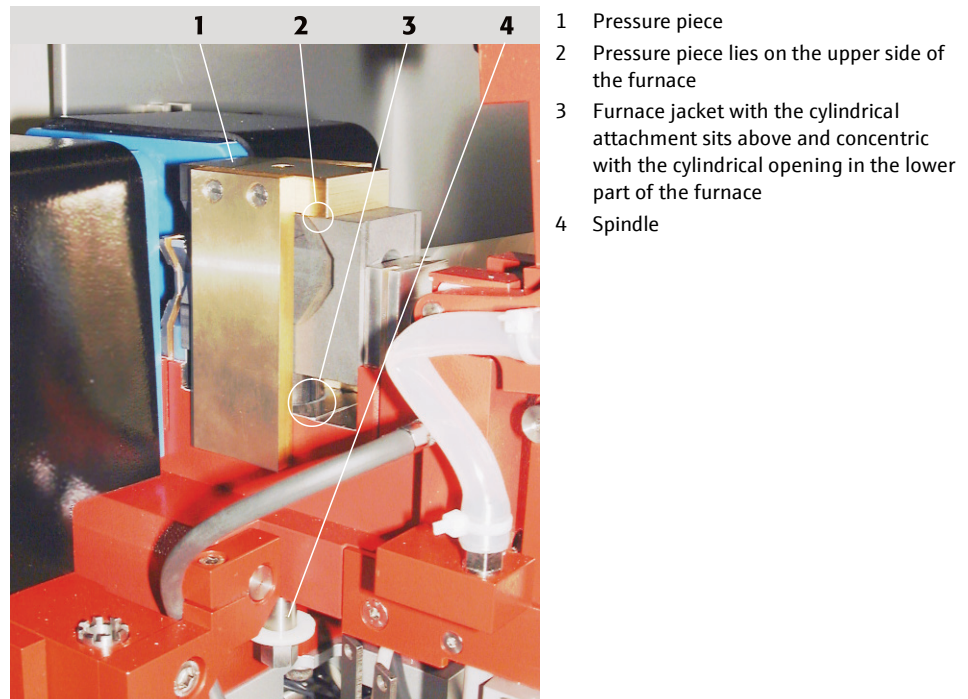

Fig. 58 Furnace jacket ready for insertion



NOTICE

Risk of destroying the electrode. Make sure that the electrode and the furnace jaws are parallel when positioning and inserting the electrode. If the electrode has been inadvertently inserted at a skewed angle, press out completely and start again.

9. Insert the electrode into the furnace carrier as far as the fixed front rest, using the spindle nut and the ratchet wrench.
10. Loosen the spindle nut and unscrew. Remove the pressure piece "lower electrode" and the spindle. Remove by suction or blow away any graphite dust which is present.
11. Leave the flange nut of the insertion tool in the furnace jacket.
12. Attach the long spindle into the pressure piece "furnace jacket".
13. Set the new furnace jacket onto the opening of the furnace carrier. Lead the pressure piece "furnace jacket" with spindle over the furnace jacket and furnace part so that the rectangular key in the opening on the upper side of the furnace jacket protrudes and the side pressure surfaces of the pressure piece lie on the furnace top side.
14. Screw the spindle nut with washer onto the free spindle end as far as the stop.



NOTICE

Danger of destruction for the furnace jacket if the torque increases abruptly during insertion. Ensure that the furnace jacket and the lower part of the furnace are always parallel to each other. If the furnace jacket is skew, press it out completely and start again.

15. Screw in the spindle nut with the ratchet wrench and insert the furnace jacket up to the stop.
16. Loosen the spindle nut and remove. Remove the pressure piece and spindle. Remove by suction or blow away any graphite dust which is present. Screw out the flange nut.
17. Install the cleaned radiation sensor. Screw in the two knurled screws finger tight.
18. Insert a graphite tube with tweezers.
19. Close the graphite tube furnace using ASpect LS with the [CLOSE FURNACE] button in FURNACE - CONTROL window.
20. Bring back the graphite tube furnace according to Section "Separation of the graphite tube furnace from the Zeeman magnet and reinsertion" p. 79 to its original position.

5.3.6 Cleaning and changing the graphite tube

Cleaning the standard graphite tube

Daily

Work steps, see Chapter "Cleaning the graphite tube (clean out)" p. 60.

Cleaning the iridium-coated graphite tube

Daily

Work steps, see Chapter "Cleaning the graphite tube (clean out)" p. 60.

| | |
|--------------------------------|---|
| Evaporation of iridium coating | After approx. 500 atomizations or for a new coating. Work steps, see Chapter "Cleaning the graphite tube (clean out)" p. 60 |
| Replacing the graphite tube | If the graphite tube appears to be burnt, the pyrolytic coating is worn out. At a formatting factor > +10 % an automatic temperature correction no longer takes place. Further use of the graphite tube should only be done with caution. The graphite tube should be changed or the temperature should be manually adapted in the furnace program. Work steps, see Chapter "Inserting the graphite tube into the graphite tube furnace" p. 57. |

5.4 Burner-nebulizer system

The burner-nebulizer system must be cleaned at regular intervals, which can be seen from the following indications:

- Irregularities in the flame hem of the burner flame. Washing with diluted acid in the active program and blowing the burner out does not bring about any improvement.
- The sensitivity given in the cookbook for an individual element is not achieved despite changing the composition of the gas.
- Build-up on the burner slit, which occurs during analysis of solutions with a high salt content, cannot be removed by the cleaning stick.



CAUTION

Risk of burns! Allow the burner to cool down before attempting any service or maintenance work.

Undertake the following maintenance work to the burner-nebulizer system:

1. Take the burner-nebulizer system apart.
2. Clean the burner.
3. Clean the nebulizer.
4. Clean the siphon.
5. Clean the mixing chamber.
6. Assemble the burner-nebulizer system.
7. Adjust the sensitivity of the burner-nebulizer system (optimize flame).

5.4.1 Taking the burner-nebulizer system apart

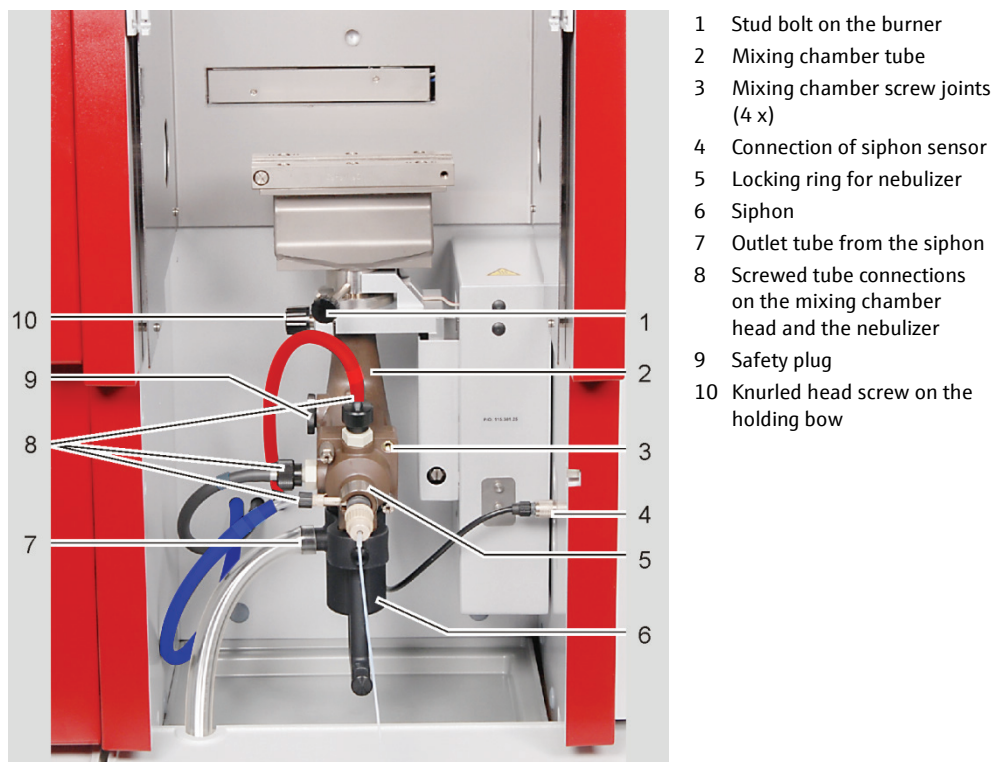

Fig. 59 Remove and disassemble the burner-nebulizer system I

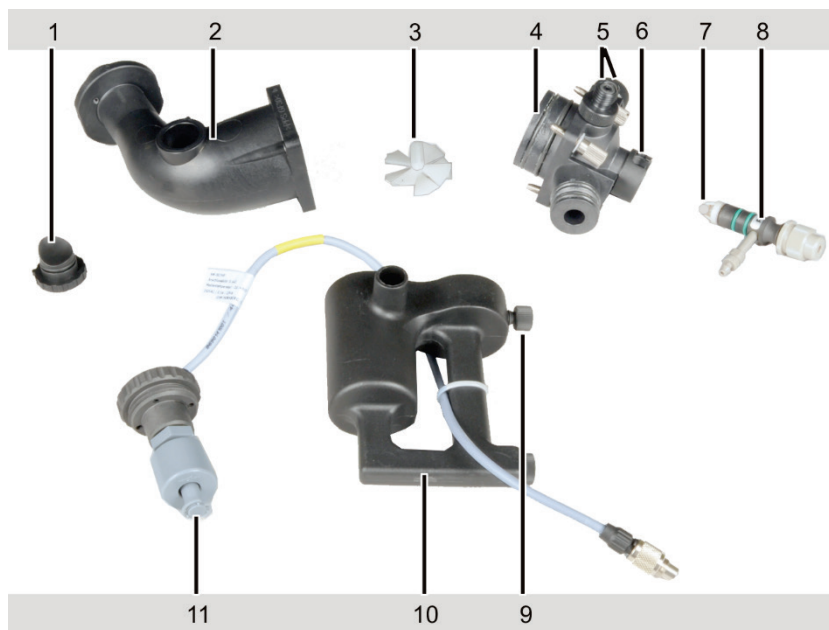

Fig. 60 Remove and disassemble the burner-nebulizer system

- | | |
|--|--|
| 1 Safety plug | 7 Impact bead |
| 2 Mixing chamber tube | 8 Nebulizer with connection for oxidant and connection for sample tube |
| 3 Impeller | 9 Clamp screw |
| 4 Mixing chamber head with connections for gases, nebulizer and siphon | 10 Siphon |
| 5 Connections for fuel gas and additional oxidant | 11 Siphon sensor |
| 6 Nebulizer connection with locking ring | |



Fig. 61 Withdrawing the nebulizer from the mixing chamber

1. Loosen the stud bolt (1 in Fig. 59 p. 89) on the burner and remove the burner from the connector.
2. Unscrew the screwed tube connections on the mixing chamber head and the nebulizer (8 in Fig. 59) and pull off the tube from the nebulizer connector.
3. Turn the locking ring of the nebulizer (5 in Fig. 59) to open the locking. Withdraw the nebulizer from the mixing chamber head, holding the nebulizer in the groove (Fig. 61).

Notice! Connector for gas connection may break when being pulled.

4. Unscrew the connection of the siphon sensor (4 in Fig. 59) on the rotating arm and pull it off.
5. Pull off the outlet tube from the outlet connector of the siphon (7 in Fig. 59).
6. Loosen the knurled head screw of the siphon (9 in Fig. 60 p. 89) and pull the siphon down.
7. Empty the siphon.

Caution! The solution in the siphon is acidic.

8. Unscrew the insert of the siphon sensor, remove the sensor from the siphon (11 in Fig. 60).
9. Hold the system tightly, loosen the knurled head screw on the holding bow of the mixing chamber tube (10 in Fig. 59), rotate the holding bow backwards and remove the system.
10. Withdraw the safety plug (1 in Fig. 60) from the mixing chamber.
11. Loosen the four screw joints of the mixing chamber (3 in Fig. 59) and disassemble the mixing chamber into the chamber head and the chamber tube.
12. Remove the impeller (3 in Fig. 60) from the chamber tube.
13. Unscrew the gas connections for fuel gas and additional oxidant.

5.4.2 Cleaning the burner

For particularly stubborn residue build-up

1. Clean the burner under running water.
2. Clean the burner with burner jaws downwards in an ultrasonic bath for 5 - 10 min with 0.1 % HNO_3 .
3. Undo the fittings (2 in Fig. 62) of the burner jaws on the burner body and remove the burner jaws.
4. Undo the fittings of the burner jaws against each other (1 and 3 in Fig. 62).
5. Remove the burnt residue build-up with the burner cleaner (timber wedge).
6. Clean the burner jaws in 0.1 N HNO_3 , and then wash with distilled water.
7. Screw the burner jaws together, making sure that the ends of the spacers on the burner slit extension and the end faces are flush.

Notice: The spacers must not protrude over the upper side of the burner jaws (arrows in Fig. 64)! When using a scraper, it remains attached.

8. Screw the burner jaws onto the burner body, the dowel pins (4 in Fig. 62) on the burner ensure correct positioning.



NOTICE

Risk of destroying the scraper!

If the spacers protrude beyond the upper side of the burner jaws, the scraper can get caught and burn away!

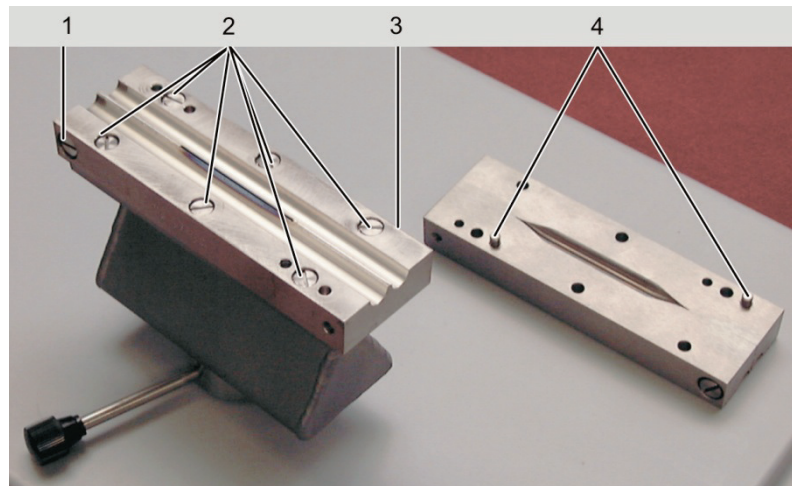

Fig. 62 Fittings of the burner

- 1; 3 Burner jaw fittings against each other
- 2 Fittings of the burner jaws with the burner body
- 4 Dowel pins on the underside of the burner jaws

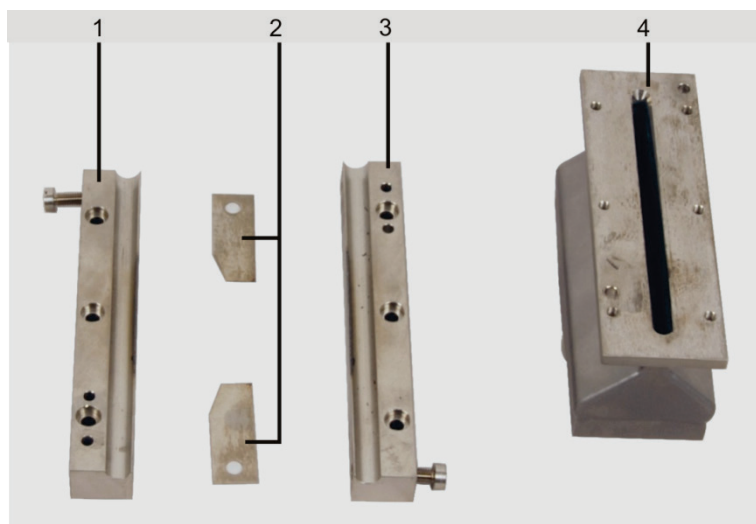

Fig. 63 Burner, disassembled

1 Burner jaw
2 Spacers

3 Burner jaw
4 Burner body



Fig. 64 Spacers inserted in burner jaws

5.4.3 Cleaning the nebulizer

1. Put the nebulizer for several minutes in an ultrasonic bath with approx. 1% nitric acid or organic solvent (isopropanol).
2. Turn the impact bead (7 in Fig. 60 p. 89) slightly and pull it off the nebulizer. Should the impact bead stuck; put the nebulizer again in the ultrasonic bath.
3. Insert the cleaning wire into the nebulizer cannula and clean the cannula by moving it up and down several times.
4. Attach the baffle ball on the nebulizer and lock it by turning slightly.

5.4.4 Cleaning the mixing chamber

Mixing chamber – chamber tube and chamber head:

1. Clean with saltpeter, diluted mineral acid, or the appropriate solvent according to the substances analyzed.
2. If the mixing chamber is cleaned with a diluted mineral acid, wash thoroughly with distilled water after cleaning.

5.4.5 Cleaning the siphon

1. Clean with saltpeter, diluted mineral acid, or the appropriate solvent according to the substances analyzed. Clean the channels with a round brush.
2. If the siphon is cleaned with a diluted mineral acid, wash thoroughly with distilled water after cleaning.
3. Wash the float holder.

5.4.6 Assembling the burner-nebulizer system



WARNING

Risk of explosion due to leaking gas connections!

When connecting the supply tubes, ensure correct connection. Insert the sealing rings and test their tightness. Only hand-tighten all screwed connections.



CAUTION

Never use the acetylene nitrous oxide flame for sensitivity fine adjustment of the nebulizer! Sudden changes in flow rate may cause a flame flashback into the mixing chamber.

1. Check all sealing rings of the chamber head, connections and the nebulizer, replace worn out sealing rings, pull on seals and ensure correct positioning.
2. Hold the impeller at the handle and insert it into the mixing chamber tube. Lock by pressing slightly.
3. Stick the mixing chamber parts (chamber tube and chamber head) together, align the sides so that they are flush and screw (3 in Fig. 59 p. 89).
4. Screw the siphon sensor (11 in Fig. 60 p. 89) in the siphon. Stick the siphon on the chamber head, align the sides so that they are flush and fasten with knurled head screw (9 in Fig. 60).
5. Attach the safety plug (1 in Fig. 60) on the chamber tube.
6. Screw the connections for fuel gas and additional oxidant (5 in Fig. 60) with the sealing rings into the mixing chamber head.
7. Stick the nebulizer (8 in Fig. 60) into the chamber head and fasten using the locking ring. **Note:** If the nebulizer cannot be stuck easily into the chamber head, slightly grease the sealing rings with the lubricant supplied (Apiezon grease).
8. Fasten the mixing chamber nebulizer system at the height adjustment using the holding bow (10 in Fig. 59). The marking must be above the edge of the holding fixture. Screw the knurled head screw at the holding bow tightly.
9. Plug the cable of the siphon sensor (4 in Fig. 59) into the connection on the rotating arm (take care with the lug) and screw tight.
10. Set the burner on the mixing chamber tube and turn against the 0° stop. Clamp with stud bolt.
11. Screw the tube for fuel gas (red) on the connector.
12. Screw the tube for additional oxidant (black) on the connector.

13. Connect the tube for oxidant (blue) to the nebulizer connector.

Sensitivity control/
adjustment

1. In the ASpect LS software, use the  button to open the FLAME - CONTROL window.
2. Set the ratio of fuel gas to oxidant.

Caution! Sensitivity fine adjustment must not be carried out with $C_2H_2 - N_2O$ flame. Sudden changes in flow rate may cause a flame flashback into the mixing chamber.

3. Align the burner head to the height of and parallel to the optical axis.
4. Use the [IGNITE FLAME] button to ignite the flame.
5. Open the MANUAL OPTIMIZATION tab.
6. Aspirate a test solution, e.g., $Cu/2$ mg/L, via the nebulizer, start the continuous measurement value display. Evaluate the signal.
7. If the sensitivity is not reached, readjust the nebulizer:

Loosen the lock nut (3 in Fig. 65). Adjust the depth of the cannula (4 in Fig. 65) with the adjustment nut.

8. After the adjustment, secure the adjustment with lock nut (3 in Fig. 65).

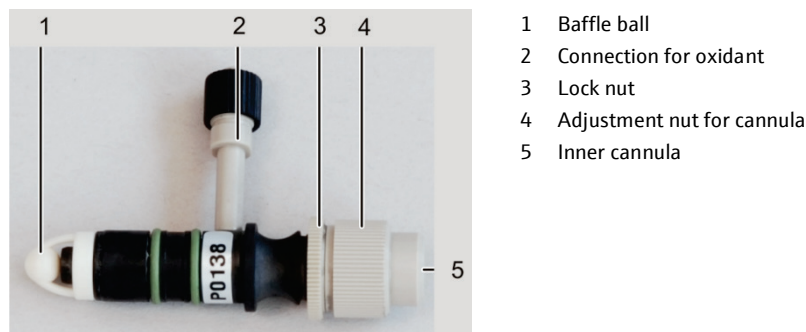

Fig. 65 Components of the nebulizer

5.4.7 Cleaning the sensor of the burner

The sensor monitors if the burner is mounted correctly before igniting the flame. Clean the sensor of the burner if

- there are deposits (for example salt incrustations) on the openings of the sensor
- the inserted burner cannot be detected (shown by an error message in the software).

1. Remove the burner-nebulizer-system by loosening the knurled head screw on the holding bow (10 in Fig. 59).
2. Clean the sensor cautiously with the help of a little brush, for example a toothbrush, using alcohol, for example Isopropanol.
3. Reinstall the burner-nebulizer-system on the holding bow.

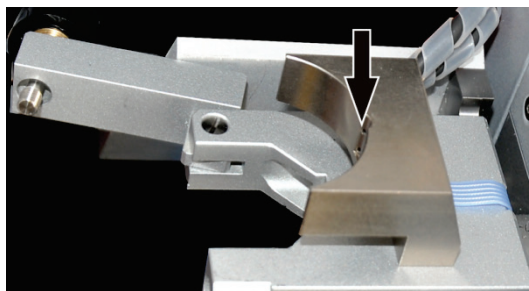

Fig. 66 Sensor of the burner

5.5 Autosampler AS-GF

The following maintenance work must be performed on the AS-GF:

- Remove any contamination from the sample tray and the casing with a dry cloth on a daily basis.
- Wash, service, replace the dosing tube.
- Clean, after a wash or mixing cup has overflowed.

5.5.1 Washing the dosing tube

The dosing tube must be washed prior to and after work. Washing solution is taken from the storage bottle, pumped via the dosing syringe into the dosing tube and dispensed into the wash cup.

1. Switch on the ZEEnit 700 P and start the ASpect LS software.
2. In ASpect LS open the window AUTOSAMPLER with .
3. Use the [WASH] button to start the wash cycle.

Note: If the dosing tube is not immersed properly into the wash cup during washing, the autosampler must be realigned in the wash position.

4. In the window FUNCTION TESTS enable the button [ADJUST AUTOSAMPLER].

In the area ALIGNMENT POSITION enable the option WASH POSITION. In the area ALIGNMENT WASH POSITION enter the immersion depth in the list field (approx. 40 mm). Correct the alignment of the swivel arm with the arrow keys. Save the configurations and exit the window.

Caution: When opening the window [ADJUST SAMPLER] again, a value of 13 mm is shown under DEPTH, not the stored value.

5. The wash cycle can be repeated several times if required.

The wash cycle can be defined in the method and thus performed automatically prior to and after the measurement.

If a method is active, pressing the [WASH] button in the AUTOSAMPLER window results in the processing of the number of Wash cycles set the method.

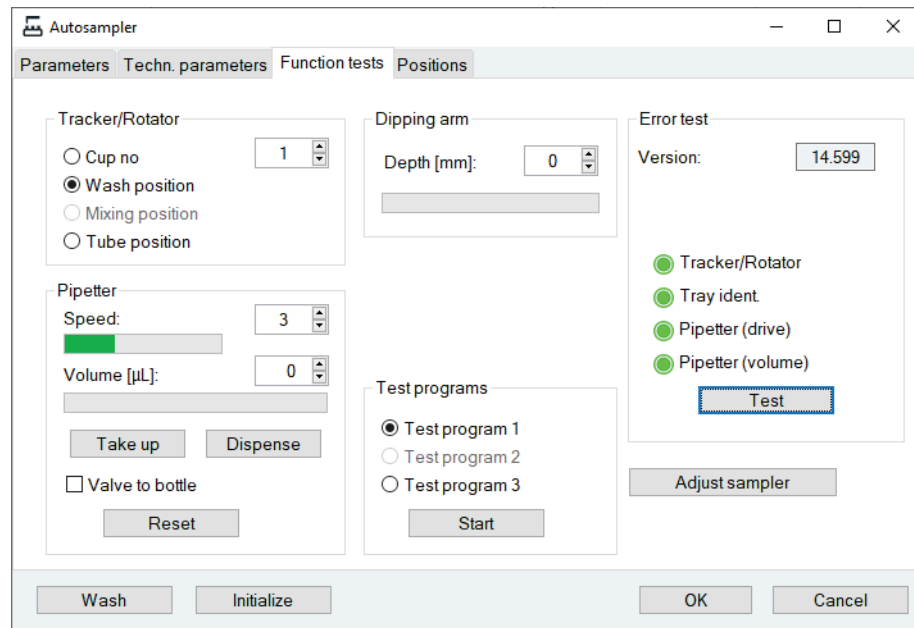

Fig. 67 Window "Autosampler/Function tests"

5.5.2 Servicing the dosing tube

A defective or kinked dosing tube or one with sediment deposits can be the cause of distorted measurement results. Maintenance work is:

- Cleaning the dosing tube
- Shorten the dosing tube
- Replace the dosing tube

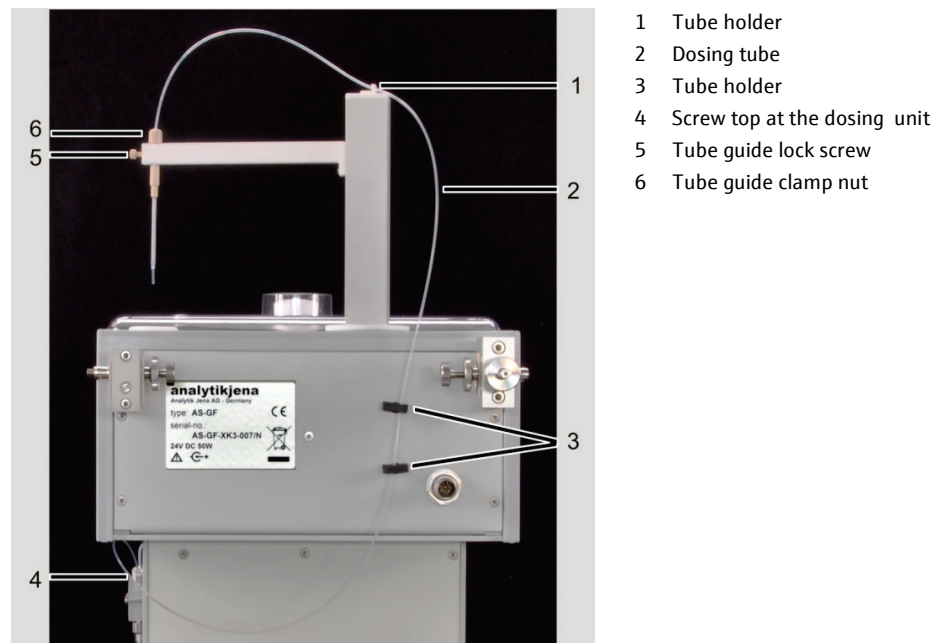



Fig. 68 Dosing tube at the AS-GF

Cleaning the dosing tube

The dosing tube requires cleaning, dependent on the sample material, when:

- The pH levels of the sample, the wash liquid and the air bubble are blurred, or if the bubble is segmented.
- The sample is spread out in the tube (tube is contaminated on the inside).

An 8 to 13% sodium hypochlorite solution (NaOCl) is recommended as a cleaning solution. The following cleaning procedure should be repeated as often as is necessary.

1. Fill the sodium hypochlorite solution into a 5 mL special cup and mount tray position 101 with it.
2. Switch on the ZEEnit 700 P and start the ASpect LS software.
3. In ASpect LS open the window AUTOSAMPLER with . Change to the tab FUNCTION TESTS (Fig. 67).
4. In the area TRACKER/ROTATOR enter "101" into the list field and enable the option CUP NO. The autosampler arm moves to position "101".
5. In the area DIPPING ARM in the list field DEPTH lower the autosampler arm into the special cup with the arrow keys (approx. 50 mm).

Note: The autosampler is only lowered if the arrow keys are used. After entering the value directly into the list field, click the arrow keys once again!

6. In the area PIPETTER, in the list field VOLUME [µL], use the arrow keys to set the volume to be picked up (approx. 100 - 200 µL). The volume can be set in steps of 50 µL.
7. Press the button [TAKE UP]. The autosampler fills the dosing tube with the cleaning liquid.
8. Allow the cleaning liquid to work for approx. 20 min.
9. In the area TRACKER/ROTATOR enable the option WASH POSITION.
10. The autosampler arm moves to the wash position.
11. In the area DIPPING ARM in the list field DEPTH lower the autosampler arm into the wash cup with the arrow keys (approx. 40 mm). When entering the value directly into the list field, click the arrow keys once again!
12. Use the [DISPENSE] button to empty the dosing tube into the wash cup.
13. Start 5 wash cycles. (Click the [WASH] button 5 times.)

Shortening the dosing tube of the AS-GF

1. Loosen the clamp nut at the tube guide (6 in Fig. 68) and remove the dosing tube by pulling upwards.
2. Cut the dosing tube with a razor blade or a scalpel at an angle of 10° to 15°.
3. Push the dosing tube as far as possible into the tube guide until the dosing tube protrudes by approx. 8 mm at the bottom.
4. Lock the dosing tube with the clamp nut.
5. Readjust the injection depth of the sample (→ section "Adjusting the AS-GF" p. 63).

Replacing the dosing tube

1. Loosen the clamp nut at the tube guide (6 in Fig. 68) and pull out the tube. Remove the tube from the tube holders at the sample arm and the back of the autosampler (1 and 3 in Fig. 68).
2. Detach the screw top from the T valve of the dosing unit (4 in Fig. 68).

3. Screw the new dosing tube to the valve and feed it through the tube holders.
4. Push the dosing tube into the tube guide until it protrudes 8 mm at the bottom, lock with the clamp nut.
5. Readjust the injection depth of the sample (→ section "Adjusting the AS-GF" p. 63).

5.5.3 Replacing the dosing device

The details below apply to the samplers AS-GF (graphite tube) and AS-FD (flame). The dosing units only differ in the size of the dosing syringe (500 or 5000 μL).

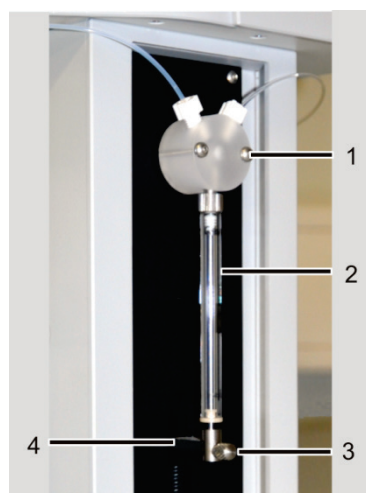

- 1 Valve
- 2 Dosing syringe, consisting of piston and glass cylinder
- 3 Attachment screw
- 4 Drive rod

Fig. 69 Dosing unit at AS-GF and AS-FD

1. Switch on the ZEE nit 700 P and start the ASpect LS software. In the window QUICK-START, select technique: GRAPHITE FURNACE (AS-GF) or FLAME (AS-FD).
2. Use  to open the AUTOSAMPLER window. Change to the tab FUNCTION TESTS.
3. In the PIPETTER area, in the list field VOLUME [μL], use the arrow keys to set the volume to be picked up (AS-GF: 500 μL ; AS-FD 5000 μL).
Increase the speed to 6-7.
4. Press the button [TAKE UP]. The piston of the dosing syringe moves down.
5. Unscrew the fixing screw (3 in Fig. 69).
6. Unscrew and remove the dosing syringe (2 in Fig. 69).
7. Screw the new dosing syringe to the valve.
8. Carefully pull the piston down until the eyelet at the piston end is aligned with the hole in the drive rod.
9. Screw the piston with the attachment screw finger-tight to the drive rod.
Notice: Excessive force can lead to damage! Do not tighten the screw too much.
10. In the window AUTOSAMPLER click on the [INITIALIZE] button.
The piston of the dosing unit moves back to the original position.

5.5.4 Clean-up after cup overflow

If during the process a wash cup has overflowed, immediately interrupt the process and clean the device.



1. Stop the process immediately.
2. Take up the liquid with cellulose wadding or cloth. Wipe the surface dry.
3. Ensure that the outlet can be drained, i.e., remove any sharp bends in the draining tube or make sure that the draining tube does not dip into the liquid in the waste bottle.

5.6 Autosampler AS-F, AS-FD

Contamination on the tray and the casing can be removed with a dry cloth on a daily basis as required. In addition according to conditions:

- Washing the sample paths
- Wash the mixing cup
- Replace the cannula(s) at the autosampler arm
- Replace the aspiration tube and dosing tube
- Replace the dosage syringe, as for AS-GF (→ Section "Replacing the dosing device" p. 98)
- Clean, after a wash or mixing cup has overflowed (as for AS-GF)

5.6.1 Washing the sample paths

1. In the software ASpect LS use  to open the FLAME WINDOW and ignite the flame.
2. Use  to open the AUTOSAMPLER window.
3. In the tab TECHN. PARAMETERS set approx. 60 s in the input field WASH TIME WASH CUP.
4. Use the [WASH] button to start the wash cycle.

The cannula of the autosampler dips into the wash cup. The wash liquid is aspirated through the system.

5.6.2 Washing the mixing cup of the AS-FD

The mixing cup must be washed before and after the operation to prevent adhesion and scaling. Before preparing the first standard / first sample the mixing cup is washed automatically. Further washing processes might be useful during continuous operation.

Washing the mixing cup prior to and after the measurement

1. In ASpect LS open the window AUTOSAMPLER with .
2. In the tab TECHN. PARAMETERS enter a volume of 25 mL in the group WASH MIX CUP.
3. Use the [START] button to start the wash cycle.
4. The wash cycle can be repeated several times if required.

25 mL of washing liquid is dispensed from the storage bottle into the mixing cup and automatically drained off afterwards.

Washing the system prior to an extended period of decommissioning

If salts were added to the diluent (bidistilled or acidic bidistilled water), the dosing unit and valve must be washed with methanol or ethanol prior to long periods of decommissioning. Otherwise scaling and blocking may also occur.

1. Fill the storage bottle for the diluent with methanol or ethanol.
2. Perform the wash cycle as described in Section "Washing the system prior to and after the measurement". Repeat the washing process several times.

5.6.3 Replacing the cannulas and guide on the autosampler arm of the AS-FD

The cannulas and guide must be replaced if there is a significant contamination or mechanical damage (detectable by large standard deviations in the measurements).

1. Pull off the hoses from the cannulas.
2. Loosen the fixing screw on the autosampler arm.
3. Pull the cannula guide with cannulas upwards and out.
4. Fit the guide with the new cannulas into the autosampler arm and fix in place with the locking screw.

Notice: Risk of fracture! Set the cannula height for them to terminate 1-2 mm above the block with the wash and mixing cup.

5. Plug the sample intake tube onto the thinner cannula. Plug the dosing tube for the diluent onto the thicker cannula.

5.6.4 Replacing the cannula on the autosampler arm of the AS-F

The cannula for picking up the sample (thin cannula) must be replaced if there is a significant contamination or mechanical damage (detectable by large standard deviations in the measurements).

1. Pull the intake tube off the cannula.
2. Loosen the lock screw at the autosampler arm and pull out the cannula.
3. Insert the new cannula and fix with the clamp nut.

Notice: Risk of fracture! Set the cannula height for them to terminate 1-2 mm above the block with the wash cup.

4. Plug the intake tube onto the new cannula.

5.6.5 Replacing the intake tube

If the intake tube is contaminated, it must be replaced.

1. Pull off the intake tube from the thinner cannula at the autosampler arm and then from the nebulizer cannula.
2. Cut a new tube to the required size and attach it on both cannulas.

5.6.6 Replacing the tube set for diluent and washing liquid at the AS-FD

1. Pull the dosing tube for diluent off the thicker cannula at the autosampler arm and feed it through the tube guide (8 in Fig. 41 p. 68).
2. Detach the tube for the washing liquid at the rear of the autosampler (5 in Fig. 42 p. 70).
3. Pull the encased tubes out of the attachment lug at the rear of the autosampler.
4. Pull the tube for the washing liquid off the storage bottle.
5. Unscrew the dosing tube from the change-over valve (3 in Fig. 43 p. 70).
6. Screw the new tube set with dosing tube (marking "1") to the change-over valve and attach the encased tubes with the attachment lug to the rear of the autosampler.
7. Insert the tube with the marking "2" into the storage bottle for the washing liquid.
8. Screw the tube for the washing liquid to the rear of the autosampler.
9. Slide the other end of the dosing tube through the tube guide onto the thicker cannula of the autosampler arm.

5.6.7 Clean-up after cup overflow

If during the process the washing cup or mixing cup (with AS-FD) has overflowed, immediately interrupt the process and clean the device.

1. Stop the measuring process immediately.
2. Take up the liquid with cellulose wadding or cloth. Wipe the surface dry.
3. Washing cup: Ensure that the outlet can be drained, i.e., remove any sharp bends in the draining tube or make sure that the draining tube does not dip into the liquid in the waste bottle.

Mixing cup (only for AS-FD):

Use  to open the AUTOSAMPLER window. Change to the tab FUNCTION TESTS.

In the area PUMPS enable the checkbox MIX CUP PUMP to start the pump.
Run the pump until the liquid has been drained off.

Disable the checkbox MIX CUP PUMP, to stop the pump

5.7 Mobile cooling unit KM 5

Note: Please observe the maintenance and care instructions in the separate operating instructions for the cooling unit.

Maintenance work

1. Check the level and cleanliness of the cooling liquid every three months.
2. If air bubbles occur in the cooling circuit (noticeable by the sound) check the water level.

Empty

1. Keep a receptacle with a capacity of 5 L easily available.
2. When the ZEEnit 700 P is switched off position the back flow tube of the KM 5 (connection is indicated by  on the KM 5) in the receptacle.
3. Switch on the KM 5.

- The water cooler is pumped out (emptied).
- Filling and ventilation
1. Open the top of the KM 5 and remove the lid of the fill opening.
 2. Fill up with 5 liters of softened water using a funnel (up to ~5 cm below the lid).
 3. Place the back flow tube in the coolant container of the KM 5.
 4. Switch on the KM 5. Allow the water cooler pump to run until the returning water is free of air. Switch the KM 5 on and off several times, as required.
 5. Switch off the KM 5. Reconnect the back flow tube to the KM 5. Close the filling opening and the lid of the KM 5.

5.8 Compressor

Note: Please observe the maintenance and care instructions in the separate operating instructions for the compressor.

- Pressure cylinder and fluid separator on the pressure reducer:

Drain oily condensate from the pressure cylinder (furnace) every week by opening the drain cock.

Caution: Risk of splashing! The furnace is under pressure. To avoid splashing of liquid, attach a hose to the cock and slowly open the cock to carefully drain the liquid into a waste bottle.

Drain oily condensation water from the pressure reducer every week by pressing the pin at the bottom of the liquid separator.

- Suction filter:

Check the filter every month. Clean or replace the filter every six months.

- Oil:

Only use the special oil SE-32! Dispose of the used oil according to the applicable regulations.

Check the oil level on the inspection glass every week. Refill oil, if necessary. Change the oil every 12 months.

- Unscrew the 4 screws and remove the ribbed cover to do this.
- Tilt the tank far enough to allow the oil to drain from the tank. Hold the motor block with one hand while draining the oil to prevent it from falling out.
- Remove any contaminations from the housing.
- Check the O ring on the ribbed cover and replace it, if required. Clean the sealing surfaces.
- Top up about 0.6 L of oil (SE-32).
- Remount the ribbed cover. Check the tightness of the ribbed cover when the device is in operation.

5.9 Injection module SFS 6

Replace the injection module tubes,

- when any contamination occurs
 - with decreased sensitivity caused by a reduced aspiration rate
1. Unscrew the PTFE tubes from the valve.
 2. Screw in the new PTFE tubes to the assigned positions.

5.10 Supply connections

See also Section "Supply and control connections" p. 40

Maintenance work

Check the gas mains for air-tightness:

1. Weekly as a safety check.
2. If the manometer indicates a clear pressure drop after shutting off the stop cock in the gas mains supply.
3. If a gas connection is open when operation is started up again.
4. Brush connections with a thickly foaming liquid (e.g., soap). If bubbles form at the gas connections when starting up, switch off the ZEEnit 700 P and disconnect the gas supply.
5. Unscrew the gas connections and check their positions. If there are sealing rings, check them. Replace worn out seals.
6. Tighten the gas connections, observing the correct positioning and check again for gas leaks.

6 Transport and storage

Auxiliary materials

- 4 handles
- 19 mm open-end wrench (included in scope of supply)



CAUTION

Risk of injury!

The ZEEnit 700 P weighs 225 kg. The device must be transported by at least 4 persons using the fixed screw-in carrying handles.



CAUTION

Risk of burns from touching hot surfaces! Observe the required cooling times of the AAS before preparing the device for transport.



NOTICE

Using improper packaging material and omitting the transport locks may cause damage to the device!

Always use the original packaging when transporting the ZEEnit 700 P. Use the transport lock to secure the monochromator.

1. Uninstall all components, see Chapter "Installation and initial start-up" p. 40. Ensure that the outlet tube has been removed from the sample chamber.
2. Remove the sample chamber door flame.
3. Close the gas supply upstream of the device connections.
4. Loosen the gas connectors on the rear of the ZEEnit 700 P:
 - Undo the argon, air and nitrous oxide tubes from the tube couplings.
 - For the acetylene gas connector, use a 19 mm open-end wrench. Left hand thread!
5. For the acetylene gas connector, use a 19 mm open-end wrench. Left hand thread!
6. Undo the quick releases on the cooling water tubes.
7. Undo the electrical connections.



NOTICE

Do not tilt the mobile cooling unit. If it cannot be transported in an upright position or if long distance transport is necessary, empty the mobile cooling unit KM5.

8. Empty the mobile cooling unit (→ Section "Mobile cooling unit KM 5" p. 101)
9. Remove the four stoppers from the holes for the handles on both sides of the device and keep in a safe place.
10. Screw the four handles securely into the holes as far as the end stops.

7 Waste disposal

Atom absorption spectrometry usually creates only liquid waste. The liquid waste contains metal ions or heavy metal ions, but mostly different mineral acids which were used during sample preparation. For safe removal of this waste, all solutions must be neutralized, for example with a diluted sodium hydroxide solution.

The neutralized waste must be brought to the appropriate waste disposal center for correct disposal according to the appropriate legal guidelines.

At the end of its service life, the ZEEnit 700 P and all its electronic components must be disposed of as electronic scrap in accordance with valid regulations.

Please dispose of the hollow cathode lamps (HCL) in accordance with the local requirements or contact Analytik Jena service personnel.

8 Specification

8.1 Technical data

8.1.1 Data for the ZEEnit 700 P

| | | | | | | | |
|-----------------------|---|----------|---|------------------|---------------|------------|--------------------------------|
| Techniques | <ul style="list-style-type: none"> ▪ Graphite tube technique for solution and solid samples in single-beam operation with Zeeman or deuterium background correction. ▪ Flame technique in single or double-beam operation with deuterium background correction. ▪ Hydride and mercury cold vapor technique in single-beam operation with deuterium background correction. ▪ HydrEA technique in single-beam operation with deuterium background correction. | | | | | | |
| Background correction | <p>Transversally arranged and microprocessor-modulated, unipolar magnetic field with 3 correction modes:</p> <ul style="list-style-type: none"> ▪ 2-field technique: The maximum field value can be selected in steps between 0.5 and 1 Tesla. ▪ 3-field technique: The field values can be selected in steps between 0.1 and 0.95 Tesla. ▪ Dynamic mode <p>Deuterium background correction with current-controlled D2HCL.</p> | | | | | | |
| Photometer | <p>Single-beam arrangement with double-beam base line stability or double-beam arrangement with beam splitter and rotating sector mirror for coupling in the reference beam path.</p> <ul style="list-style-type: none"> ▪ High light yield. ▪ Quartz-improved mirror optics. ▪ Wide-range photomultiplier, R928, 9-stage. ▪ Quartz polarizer with anti-reflex coating and UV-optimized transmission, can be moved from the path of the beam. | | | | | | |
| Monochromator | <table border="1" style="width: 100%; border-collapse: collapse;"> <tr> <td style="padding: 5px;">Assembly</td> <td style="padding: 5px;">Modified Czerny-Turner layout with a flat hologrid, automatic wavelength and slit width setting</td> </tr> <tr> <td style="padding: 5px;">Wavelength range</td> <td style="padding: 5px;">185 to 900 nm</td> </tr> <tr> <td style="padding: 5px;">Slit width</td> <td style="padding: 5px;">0.2 nm, 0.5 nm, 0.8 nm, 1.2 nm</td> </tr> </table> | Assembly | Modified Czerny-Turner layout with a flat hologrid, automatic wavelength and slit width setting | Wavelength range | 185 to 900 nm | Slit width | 0.2 nm, 0.5 nm, 0.8 nm, 1.2 nm |
| Assembly | Modified Czerny-Turner layout with a flat hologrid, automatic wavelength and slit width setting | | | | | | |
| Wavelength range | 185 to 900 nm | | | | | | |
| Slit width | 0.2 nm, 0.5 nm, 0.8 nm, 1.2 nm | | | | | | |

Lamp turret for HCL PC-controlled 8-lamp turret for fully automated operation with a write/read unit for the use of coded lamps.

Hollow cathode lamps HCL, coded Lamp type: Glow discharge lamps for 68 elements with line radiation in the UV/VIS range. The use of uncoded lamps is possible.

| | |
|--------------|---|
| Lamp current | 2 to 20 mA |
| Mode | Electrical timing <ul style="list-style-type: none"> ▪ in Zeemann operation 2-field and 3-field modes 200 Hz ▪ in D2 graphite furnace mode and hydride mode 100 Hz ▪ in flame mode 50 Hz |
| Power supply | 2 power packs, electrically stabilized <ul style="list-style-type: none"> ▪ for active lamps ▪ for preheating |

Super-hollow cathode lamps, coded Lamp type: Glow discharge lamps with additional discharge. Line radiation in the UV/VIS range. The use of uncoded lamps is possible.

| | |
|---------------|---|
| Lamp current | 2 to 20 mA |
| Boost current | 0 to 50 mA |
| Mode | Electrical timing <ul style="list-style-type: none"> ▪ in Zeemann operation 2-field and 3-field modes 200 Hz ▪ in D2 graphite furnace mode and hydride mode 100 Hz ▪ in flame mode 50 Hz |

Deuterium hollow cathode lamp D2HCL Lamp type: Glow discharge lamp with continuum radiation in the UV range.

| | |
|--------------|---|
| Lamp current | 5 to 35 mA |
| Mode | Electrical timing <ul style="list-style-type: none"> ▪ in graphite furnace mode and hydride mode 100 Hz ▪ in flame mode 50 Hz |

Analytical working modes in absorption Total absorption
Specific and unspecific absorption

| | | |
|---------------|-----------------|--|
| Display modes | Absorbance | -0.01 to 3.00 |
| | Concentration | Value range: 5 characters (0.001 to 99999), unit freely selectable |
| | Emission | 0 to 1; possible in flame mode |
| | Standard energy | 0 % to 100 % |

| | Median statistics | | | | | | |
|---------------------------------------|---|-------------------|------|-------------------|---------|--------|--------------|
| | <ul style="list-style-type: none"> ▪ Media value with range (R) and relative range (R%) | | | | | | |
| Confidence interval | Can be selected: Absolute, relative or none Selectable confidence interval: 68.3 % (1 σ) 90 % (1.6 σ) 95.4 % (2 σ) 99 % (2.6 σ) 99.7 % (3 σ) 99.9 % (3.6 σ) | | | | | | |
| Calibration | Calibration techniques Standard calibration (recalibration) Bracketing calibration Standard addition (for solid techniques 3D display) Addition calibration | | | | | | |
| | Fit reference curve Linear, variable weighting functions Non-linear, variable weighting functions | | | | | | |
| | Number of standards 1 to 30 | | | | | | |
| | Number of addition concentrations 1 to 30 | | | | | | |
| | Recalibration Two-point recalibration with display of the recalibration factor | | | | | | |
| Power supply | Supply voltage 230 V ~ | | | | | | |
| | Frequency 50/60 Hz | | | | | | |
| | Mains fuse installation in the building Safety fuse 35 A, slow blow No automatic fuse devices! | | | | | | |
| | Typical average power consumption 2100 VA | | | | | | |
| | Maximum current consumption 52 A for a period of 8 s or 85 A for 1 s | | | | | | |
| | Output socket Like input socket (230 V ~, 50/60 Hz) For connection of accessories: PC, printer, hydride system | | | | | | |
| | Overvoltage category II according to DIN EN 61010-1 | | | | | | |
| | Degree of contamination 2 according to DIN EN 61010-1 | | | | | | |
| | Safety class I | | | | | | |
| | Safety type IP 20 | | | | | | |
| Instrument fuses Power supply fuse | <p>The power supply fuses may only be changed by service engineers from Analytik Jena or by technical personnel authorized by Analytik Jena.</p> <p>gL-instrument fuse fittings (10×38 mm²) according to 60947-3.</p> <table border="1"> <thead> <tr> <th>Fuse number</th> <th>Type</th> <th>Protected circuit</th> </tr> </thead> <tbody> <tr> <td>F1 / F2</td> <td>32 A/T</td> <td>Power supply</td> </tr> </tbody> </table> | Fuse number | Type | Protected circuit | F1 / F2 | 32 A/T | Power supply |
| Fuse number | Type | Protected circuit | | | | | |
| F1 / F2 | 32 A/T | Power supply | | | | | |

Instrument fuse fittings (5×20 mm²) according to IEC 60127.

| Fuse number | Type | Protected circuit |
|-------------|-----------|---------------------------------|
| F3 / F4 | T 6.3 A/H | Socket for external accessories |
| F5 / F6 | T 2.5 A/H | Transformer, primary side, NTL |
| F7 / F8 | T 6.3 A/H | Power supply of the magnet |
| F9 | T 0.08 A | D2-HCL |
| F10 | T 0.25 A | HCLs |
| F11 | T 0.08 A | Boost current |
| F12 | T 1 A | Heating for boost current |
| F13 | T 0.032 A | Analog |
| F 14 | T 3.15 | Filament |

Internal fuses

| Fuse number | Type | Protected circuit |
|-------------------|--------------|--------------------------------|
| F1 internal | TR5-T 100 mA | Zeemann furnace measuring lead |
| F1 internal MagPS | FF 4 A/H | Power supply of the magnet |

Environmental conditions According to DIN ISO 90022-2:2003 / 01

| | |
|--|--|
| Corrosion protection | The device is corrosion-proof for the samples used in the analysis |
| Working temperature | +10 °C to +35 °C |
| Humidity during operation | Max. 90 % at +30 °C |
| Storage temperature (use drying agent) | -40 °C to +70 °C |

Dimensions and weights

| | |
|-------------------------|--|
| Mass | 230 kg |
| Dimensions (W x H x D): | 1180 mm × 650 mm × 735 mm |
| Transport of device | Only possible using the corresponding carrying handles which must be securely screwed into place |

8.1.2 Minimum requirements of the ASpect LS software

| | |
|------------------|--|
| Computer | Resolution 1280x1024 pixels or higher Mouse / trackball 2 x USB-2.0 interfaces |
| Operating system | PC with Windows 8.1 or 10 (32 bit or 64 bit) |

8.1.3 Data for the graphite tube technique

| | | |
|-----------------------|--|---|
| Graphite tube furnace | Type of sample | Liquid Solid |
| | Type of tube | IC tube (wall atomization) IC tube with 1-PIN platform IC tube solid All tube types are pyro-coated. |
| | Volume | Max. 50 µL |
| | Temperature setting | Temperature can be set between room temperature and 3000 °C, in steps of 1 °C |
| | Temperature-time programming (furnace program) | Up to 20 steps can be freely programmed within determined limits, 0 to 999 s/step, in intervals of 1 s Temperature increase (ramp): 1 °C/s to 3000 °C/s linear and maximum non-linear ramps (Full Power FP / No Power NP) Control of inert gas and auxiliary gas Inserting injection and enrichment steps Determining the starting point for autozero and integration |
| | Cooling water | Min. 2.5 L/min, sediment-free 20 °C to 40 °C |
| | Inert gas | Argon 4.8 and superior Permitted components: Oxygen ≤3.0 ppm Nitrogen ≤10.0 ppm Hydrocarbons ≤0.5 ppm Humidity ≤5.0 ppm Consumption Max. 2 L/min (depending on temperature-time program) Inlet pressure: 600 to 700 kPa |
| | Safety circuits ensuring protection against | If transformer for furnace heating is overheated If the magnet coils are overheated If the graphite tube is broken If the graphite tube furnace is overheated If the graphite tube furnace is open during operation If there is a shortage of cooling water If the inlet pressure of the inert gas is too small If malfunctions occur in the magnetic control system and the supply system |
| | Autosampler AS-GF | Autosampler with dilution function, completely PC controlled |
| Sample tray | 108 positions | |
| Sample cups | 100 pieces, 1.5 mL | |
| Special cups | 8 pieces, 5 mL | |
| Pipetter volume | 1 to 50 µL | |
| Wash volume | 0.5 mL, number of wash cycles can be selected | |
| Program methods | Standard Modifier | |

| | |
|--------------------------------|--|
| | Dilution Addition Automatic enrichment |
| Mass | 7.2 kg |
| Mobile cooling unit KM 5 | Air cooler with thermostat; CFC free |
| Tank capacity | 5 L |
| Capacity | 3 L/min |
| Accessories for solid analysis | SSA 600 Solid autosampler for automatic operation |
| | SSA 6 Solid autosampler for manual operation |

8.1.4 Data for the flame technique

| | | |
|-------------------|--|---|
| Types of flame | Acetylene/air | One-slit burner 50 mm, coded (standard) One-slit burner 100 mm, coded (optional) |
| | Acetylene/N ₂ O | One-slit burner 50 mm, coded |
| Oxidant | Compressed air and N ₂ O | Inlet pressure: 400 to 600 kPa |
| | Nebulizer flow | |
| | Air | 400 to 600 NL/h |
| | N ₂ O | 320 to 480 NL/h |
| | Additional oxidant (air or N ₂ O) | |
| | Air | 3 levels 75 / 150 / 225 NL/h |
| | N ₂ O | 3 levels: 60 / 120 / 180 NL/h |
| Fuel gas | Acetylene | Inlet pressure: 80 to 160 kPa Consumption: 40 to 315 NL/h |
| Nebulizer | Mode of action | Pneumatic radial clearance nebulizer |
| | Material | Platinum/rhodium cannula, graphite nozzle |
| | Nebulizer 0.7 | Throughput rate 4 to 7 mL/min |
| Siphon monitoring | Mode of action | Float, corrosion proof |
| Burner adjustment | Height | 5 to 15 mm, automated |
| | Rotation | 0 to 90 deg., manual |
| Safety circuits | Monitoring of | Burner and burner type Fuel gas pressure Oxidant input pressure (air and N ₂ O) Siphon level Flame |

| | | |
|-------------------------|---|---------------------------------|
| Autosampler AS-F | Autosampler without dilution function, completely PC-controlled | |
| | Sample tray 139/ 15 | |
| | Sample cups | 129 pieces, 15 mL |
| | Special cups | 10 pieces, 50 mL |
| | Sample tray 54/ 50 | |
| | Sample cups | 54 pieces, 50 mL |
| | Power supply | Via AAS basic instrument |
| | Wash bottle | 2 L |
| Mass | 6.5 kg | |
| Autosampler AS-FD | Autosampler with dilution function, completely PC-controlled | |
| | Sample tray 139/ 15 | |
| | Sample cups | 129 pieces, 15 mL |
| | Special cups | 10 pieces, 50 mL |
| | Sample tray 54/ 50 | |
| | Sample cups | 54 pieces, 50 mL |
| | Dosing unit in the Fluidics module | 5 mL |
| | Power supply | Via AAS instrument |
| | Wash bottle | 2 L |
| | Bottle for diluent | 2 L |
| | Mass (total) | 10.0 kg |
| Autosampler | 6.5 kg | |
| Fluidics module | 3.5 kg | |
| Injection module SFS 6 | PC-controlled | |
| | Sample volume for individual analysis | 300 µL (minimum volume) |
| | Power supply | Via AAS basic instrument |
| Piston compressor | PC-controlled | |
| | Tank capacity | 15 L |
| | Measurements (diameter × height) | 400 mm × 480 mm |
| | Power supply | 230 V, 50 Hz or 230 V, 60 Hz |
| | Mass | 27 kg |
| | Max. operating pressure | 800 kPa |
| Scraper | PC-controlled | |
| | Power supply | Via AAS basic instrument |
| Mercury/hydride systems | HS 60 modular, HS 55 modular, HS 50 for Hydride- and HydrEA-technique | |
| | See the instruction manual for mercury/hydride systems | |

8.2 Guidelines and standards

| | |
|--|---|
| Protection class and protection rating | <p>The ZEEnit 700 P has the protection class I.</p> <p>The casing has the protection rating IP 20.</p> |
| Device safety | <p>The ZEEnit 700 P complies with the safety standards</p> <ul style="list-style-type: none">▪ DIN EN 61010-1 (VDE 0411T.1; IEC 61010-1)▪ DIN EN 61010-2-061 (IEC 61010-2-061) |
| EMC compatibility | <p>The ZEEnit 700 P is tested for suppression of radio interference, noise immunity and interference emission and fulfils the respective requirements</p> <ul style="list-style-type: none">▪ DIN EN 61326 |
| Environmental compatibility | <p>The ZEEnit 700 P has been tested for environmental compatibility and fulfills the requirements stipulated by</p> <ul style="list-style-type: none">▪ DIN ISO 9022-3:2000▪ DIN ISO 9022-32-03-0▪ DIN ISO 9022-2:2003/01 |
| Directives for China | <p>The device contains restricted substances (according to directive "Management Methods for the Restriction of the Use of Hazardous Substances in Electrical and Electronic Products"). Analytik Jena guarantees, that those hazardous substances may not leak out during the next 25 years when the device is used in accordance with its intended purpose.</p> |
| EU directives | <p>The ZEEnit 700 P is built and tested according to standards that fulfill the requirements stipulated by the EU directives 2014/35/EU and 2014/30/EU.</p> <p>Each device leaves the manufacturer in a pristine and technically safe state. To maintain this condition and to ensure safe operation, the operator must strictly observe the safety and operating instructions contained in this manual. For accessories which have also been supplied, and system components from other manufacturers, their operating instructions should be referred to.</p> |