

High-Resolution Array ICP-OES PlasmaQuant® PQ 9000

Inductively Coupled Plasma Optical Emission Spectrometry



PlasmaQuant
PQ 9000 Elite

PlasmaQuant® PQ 9000 Series

Convince yourself of impressive analytical performance and experience what innovative high-end technology actually means.

Clever details of the PlasmaQuant® PQ 9000 series:

- **High-Resolution Optics**
Unique resolving power for unconditional confidence in results
- **V Shuttle Torch**
Intelligent torch design for comfortable high-end functionality
- **Dual View PLUS**
Flexible plasma views for most comprehensive applicability
- **High-Frequency Generator**
Absolute plasma power for compelling long-term performance



PlasmaQuant® PQ 9000

Cost-effective analysis without compromises

PlasmaQuant® PQ 9000 Elite

High-resolution technology in a revolutionary small design

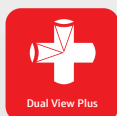

PlasmaQuant[®] PQ 9000

Measure to the point!



Designed for Anything

Benefit from our experience in the development of high-end spectrometers. With a unique high-resolution array technology Analytik Jena offers ICP-optical emission spectrometers of unparalleled performance!



Whether you are interested in consistent routine elemental analysis or very specialized applications—the PlasmaQuant® PQ 9000 series easily fulfills all of today's analytical requirements: simplicity, applicability and accuracy!

Advances in torch engineering and plasma technology, a bench-top instrument concept, elaborate software routines and a well-proven spectrometer design ensure highest accuracy, precision and method flexibility as well as a new generation in operator convenience.

PlasmaQuant® PQ 9000 Series – Pioneering Technology

The outstanding analytical capabilities of the PlasmaQuant® PQ 9000 series arise from synergetic interactions between its four patented key components:

- High-Resolution Optics
- V Shuttle Torch
- Dual View PLUS
- High-Frequency Generator

Trusting in the accuracy generated by the **High-Resolution Optics** unconditional confidence in analytical results becomes a reality.

The intelligent concept of the **V Shuttle Torch** helps you focus on your analytical task, while best optical precision and highest matrix tolerance are constantly achieved.

Dual View PLUS plasma observation will extend both your working range and detection limits beyond traditional boundaries of ICP-OES.

Delivering plasma that withstands virtually all sample loads and matrices the **High-Frequency Generator** reduces your sample pretreatment to a minimum and offers you reproducibility without compromises.

A New Standard

In trace analysis of complex materials it is the sample that dictates your instrumental needs. High matrix contents require high plasma performance! Unique detection limits ask for a unique spectrometer design!

The PlasmaQuant® PQ 9000 and the PlasmaQuant® PQ 9000 Elite offer a wealth of analytical potential! Their innovative components designed to overcome analytical shortcomings of the past set a new standard in analytical performance.

PlasmaQuant® PQ 9000 – Convincing All-Rounder

Direct analysis of volatile or matrix-rich samples can enhance trace detection, but it is often impractical. Built to withstand the most challenging materials, it is only the latest plasma and torch technology from Analytik Jena that succeeds in the direct analysis of volatile organics, brines and many other materials! Whether aiming for on-off measurements of unknown materials, high method flexibility in shift-operation or continuous aspiration of extreme sample loadings, **PlasmaQuant® PQ 9000** is your instrument of choice! Make use of the lowest matrix-specific detection limits and benefit from a reduction in sample handling that improves precision, productivity and ease of use.

PlasmaQuant® PQ 9000 Elite – Premium Detection

In advanced material analysis by ICP-OES, high-resolution has become the key feature to ensure effectiveness in data acquisition and premium operator comfort. Given the complex composition of industrial products and research samples, only the highest spectral resolution warrants the best precision and detection limits. Removing common spectral interferences the most sensitive emission lines can be used in almost any sample – ensuring superb trace detectability!

Experience high-resolution of the highest standards: The unmatched resolving power of the **PlasmaQuant® PQ 9000 Elite** brings clarity, simplicity and confidence to your most delicate analytical routines.





Intelligent Torch Concept

Matrix-rich samples like saline, metallic or petrochemical materials require a sampling system that is both simple and durable, while delivering rigid plasma under extreme matrix loads.

Clearly laid out and easily accessible the sampling system of the PlasmaQuant® PQ 9000 Series is characterized by short distances between a 12-roller peristaltic pump, an EasyFit® nebulizer, a cyclonic spray chamber and the **V Shuttle Torch**. This enables uniform sample introduction, high aerosol yields and reduced wash-out times, which along with a speed mode of the four channel peristaltic pump significantly reduce delay times. Besides, productivity enhancing accessories and hydride generation can be operated simultaneously.

Reliable Plasma Performance

It is the up-right plasma geometry of the V Shuttle Torch that makes long-term plasma performance without clogging and soot formation the rule – even for your most difficult samples. Accuracy (RSD), blank values and the range of samples to be analyzed without wet chemical pre-treatment improve significantly with this deposit-free vertical torch.

Practical Shuttle Design

Made from thermally and chemically resistant material, the advantages of a firm and sliding torch base (shuttle) with built-in gas connections are obvious and manifold.

Helping you focus on your analytical task the installation of the appropriate torch tubes follows a convenient plug-and-play routine, which reduces torch handling to a minimum, simplifies maintenance and increases method flexibility.

All torch gases are instantly connected when the shuttle locks into a rail guide; on which it easily slides into sampling position. The comfort and safety of this procedure is further complemented by the quality of the attained auto alignment of the V Shuttle Torch.

While the high optical precision of the V Shuttle Torch translates into unrivalled reproducibility of your ICP-OES data, its clever design cuts short instrument down-time and contributes to lower maintenance costs.



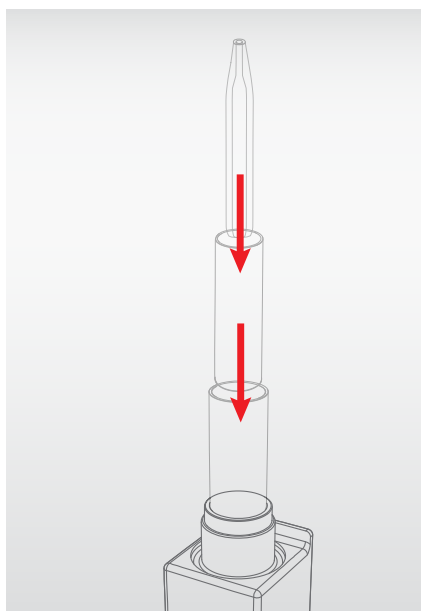

Plug-and-Play

It only takes a simple motion of one hand to firmly install torch tubes and injector in the V Shuttle Torch.

One by one the tubes and injector are readily inserted or removed from the top of the shuttle, while tapered glass joints make a tight seal automatically.

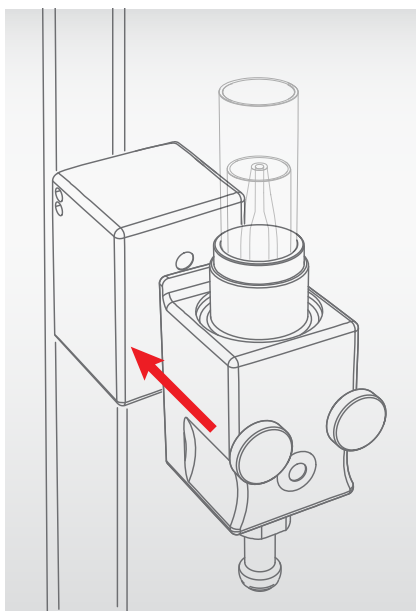

Shuttle Interlock

Without the need for adjusting aids the V Shuttle Torch simply docks to a molded adapter and is affixed merely by the twist of a knob. A gas-tight supply of Argon to the V Shuttle Torch is realized by built-in brass flanges, which ensure safe and lasting glass-free and tube-free connections.

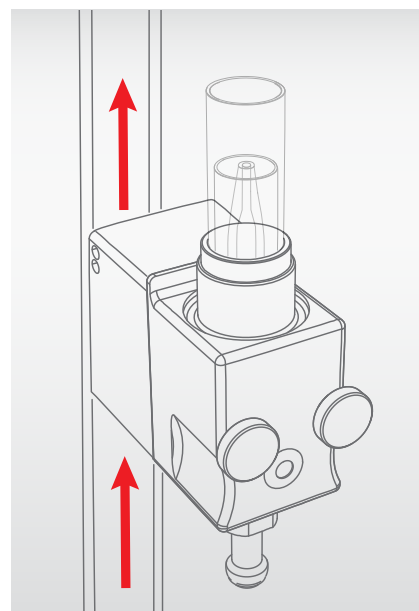

Auto Alignment

Smoothly sliding on a rail guide, the V Shuttle Torch is led into sampling position by hand where it clicks into place. This easy routine permits the effortless interchange of the torch between methods or during maintenance without any re-alignment, which will make all the difference in your lab.



V Shuttle Torch – Your Benefits

- Unrivalled ease of use in any routine
- Exceptional tolerance of high matrix loads
- Outstanding analytical performance
- Low maintenance efforts and consumable costs
- Carefree operation increasing your productivity

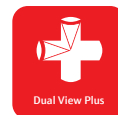

The Added Extras

In complex samples the ideal plasma view usually differs for trace elements and major constituents. So, restriction to either axial or radial plasma view lowers the analytical performance and method flexibility.

A novel tool in HR atomic spectrometry, **Dual View PLUS** allows modulating the signal intensities of emission lines simply by selection and attenuation of plasma views offering ideal plasma views for all elements and contents. Adding an extra tuning parameter, automatic attenuators in axial and radial observation extend the linear working range and increase applicability.

Widest Working Range

Fast adaptation of plasma views and all viewing positions to the required sensitivity of each element enables supreme operator flexibility in particular since multiple plasma views can be used in one run. Dual View PLUS means free selection of 2+2 plasma views in every sample for synchronous analysis of contents ranging from low ppb to high weight percent, instead of lengthy sample preparation.

Argon-Neutral Counter-Gas-Technology

Detrimental recombination interferences, self-absorption of the cool plasma tail, oxygen, particles and heat are fully removed from the optical path by the latest counter-gas technology, which neither perturbs the stability of the vertical plasma radially nor reduces the length of its analytical zone axially.

The quality of the spectral data obtained by Dual View PLUS reaches well-beyond traditional boundaries of ICP-OES taking detection capabilities in axial and radial PLUS plasma views as well as the overall signal stability a major step ahead.

Re-using the recycled purge gas makes the counter-gas technology of the PlasmaQuant® PQ 9000 series argon-neutral.

Dual View PLUS contributes to exceptional sensitivity across all applications and meets the requirements of your analytics with ease and excellent cost-effectiveness.



Versatile Dual View PLUS plasma view benefits both the ultra-trace analyses of cleanroom laboratories and heavy-duty industrial screening routines.

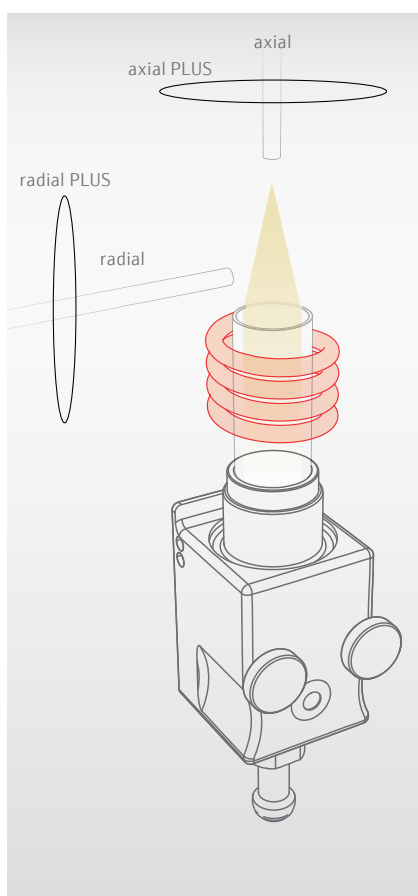

radial and radial PLUS

Sampling only a narrow zone of the plasma, side-on radial views on the PlasmaQuant® PQ 9000 series are the first choice for interference-free analysis of mid-range contents to high weight percentages.

In **radial PLUS** attenuation of the radially collected light circumvents signal saturation and self-absorption of emission lines in highly concentrated samples.

Truly extending the linear working range of ICP-OES towards higher concentrations, radial PLUS plasma view greatly reduces labor-intensive and time-consuming sample preparation and improves your productivity.

axial and axial PLUS

Providing unique sensitivity, axial plasma views on the PlasmaQuant® PQ 9000 series permit robust trace analysis from the high ppm to sub-ppb range. Its detection limits that reach parts per trillion are an innovation in ICP-OES.

In **axial PLUS** spectral information of the full analytical zone of the plasma is collected, yet its intensity is automatically attenuated to adapt sensitivities of elemental lines. That avoids sample dilution or change to radial plasma observation, which requires individual optimization for samples with high analyte contents.

Strictly providing additional means for the analysis of mid-range elemental contents, axial PLUS plasma view especially benefits analytical routines that face huge matrix diversity and requires first-class reproducibility of data at any time.

Dual View PLUS – Your Benefits

- Best plasma views for all elements and concentrations
- Widest working range of any ICP-OES
- Argon-neutral counter-gas-technology for unique sensitivity
- Increased productivity across all applications
- A new generation of operator convenience



High Resolution

Powerful detection limits are the key to accuracy, robustness and simplicity in routine analysis. Facing complex matrices, signal suppression and spectral interferences only the best spectrometers permit maximum sensitivity and supreme spectral resolution.

With a unique resolving power the **High-Resolution Optics** of the PlasmaQuant® PQ 9000 Elite guarantee for an unmatched sensitivity in real sample matrices. This well-established encapsulated echelle spectrometer utilizes a double monochromator set-up of prism and grating along with the latest high-resolution HR CCD detector generation for interference-free routine analysis with excellent productivity.

Interference-free Analytics

With 2 pm at 200 nm the spectral resolution of the PlasmaQuant® PQ 9000 Elite is simply remarkable and reveals even the smallest spectral details. Typical spectral interferences are all resolved. As the most sensitive emission lines can be used in almost any sample best detection limits are constantly achieved and often reach into the parts per trillion!

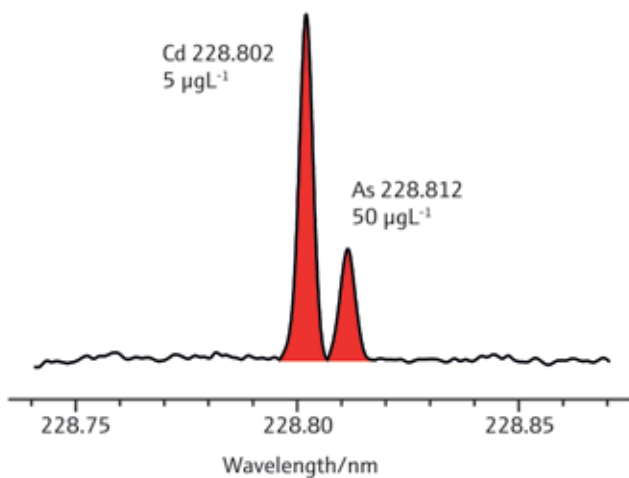

Only a few picometers apart the Cadmium and Arsenic line are well-separated and can be used analytically without difficulty.

warranty conditions: www.analytik-jena.com

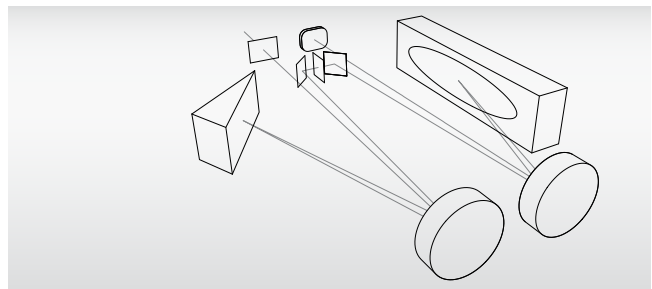

A compact ensemble of high-end optical components yields the unrivalled resolving power of the PlasmaQuant® PQ 9000 Elite.



High Productivity

Owing to the latest HR CCD detector generation, the PlasmaQuant® PQ 9000 series provides high quantum efficiency, a dynamic range of six orders of magnitude, instant simultaneous background correction, increased UV-sensitivity and in addition signal integration modes for best detection limits, simultaneous evaluation of multiple elements and wavelength scans.

Exceptional wavelength accuracy of less than 0.4 pm is achieved by neon correction that eradicates the need for thermostating of the spectrometer and frequent wavelength calibration.

An innovative coating for the optical components eliminates losses of scattered light and offers superior sensitivity for a continuously covered wavelength range from 160 to 900 nm with access to more than 43,000 emission lines.

High-Resolution Optics – Your Benefits

- Greatest range of lines for superior flexibility
- Interference-free analytics for highest accuracy
- Lowest detection limits in real samples for excellent method robustness



Exceeding the Limits

The feasibility of trace analytics in highly concentrated samples by ICP-OES strongly depends on the instrumental plasma performance towards rapidly varying sample types, loadings and matrices.

The latest plasma technology of the **High-Frequency Generator** offers unrivaled plasma performance even for extreme loadings and matrices. In addition to a significant extension of the application range, lower matrix-specific detection limits and reduced sample preparation enhance method robustness, precision and productivity.

Robust Direct Analysis

Utilizing a heavy-duty four-winding induction coil, the free-running 40 MHz power tube generator readily transfers power ranging from 700 up to 1700 W with the highest efficiency into plasma of outstanding length. Its unique high-power settings required for industrial routine analysis of materials like brines, metal concentrates and volatile organics clearly make plasma collapse a relic of the past.

Instantly matching its RF power output to the current plasma loading, the High-Frequency Generator enables ultimate consistency of plasma conditions that lead to unrivalled long-term signal stability of all emission lines. Marginal intensity drifting over an average working day and RSD-values about 1% for common matrices surely enhance the precision of your ICP-OES routines.

Realizing excellent signal-to-noise levels of the acquired spectral data and enhanced sensitivity, the High-Frequency Generator offers advanced analytical capabilities and high operator flexibility.

Cost-effective Analytics

Short warm-up intervals speed-up torch maintenance, increase method flexibility and facilitate shift-operation with uncompromised precision and low running costs. With the PlasmaQuant® PQ 9000 series instrumental shut-down and short warm-up times are no longer a contradiction, but true time-savers that benefit your productivity!

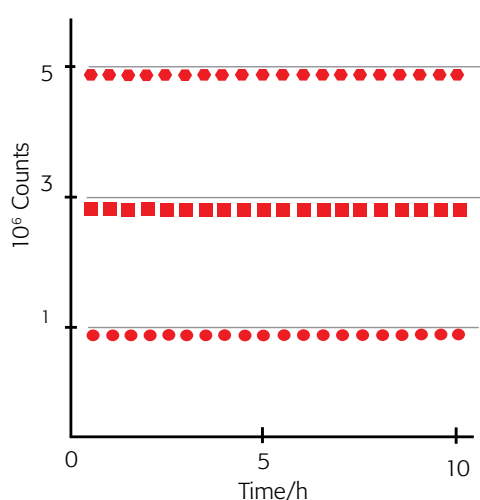

Superb long-term signal stability for all emission lines offered by the High-Frequency Generator: Li 670 nm (●), Mn 257 nm (■), Al 396 nm (●)

High-Frequency Generator – Your Benefits

- Highest matrix tolerance of the market for enhanced applicability
- Carefree operation and exceptional method flexibility
- Superb RSD-values with minimal effort
- Shift-operation with uncompromised precision
- Significant increase in productivity

PlasmaQuant® PQ 9000 Elite

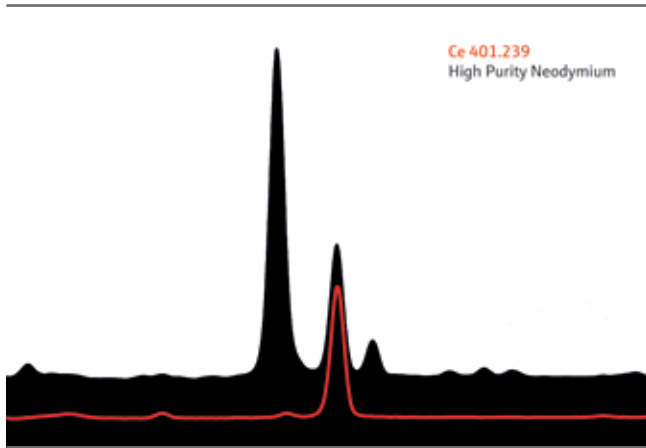

Premium Detection

The **High-Resolution Optics** of the PlasmaQuant® PQ 9000 Elite reveals even the smallest spectral details, warrants the best precision and delivers previously impossible detection limits in the most challenging sample matrices with high ease of use.

Technical Genius

Highly effective spectrometry technology made in Germany and unique software solutions ensure peak performance in advanced materials analysis, quality control, research etc. with outstanding flexibility and first-class operator comfort.

Market Leader

Setting new standards the High-Resolution Array ICP-OES technology by Analytik Jena makes unconditional confidence in your analytical results a reality.

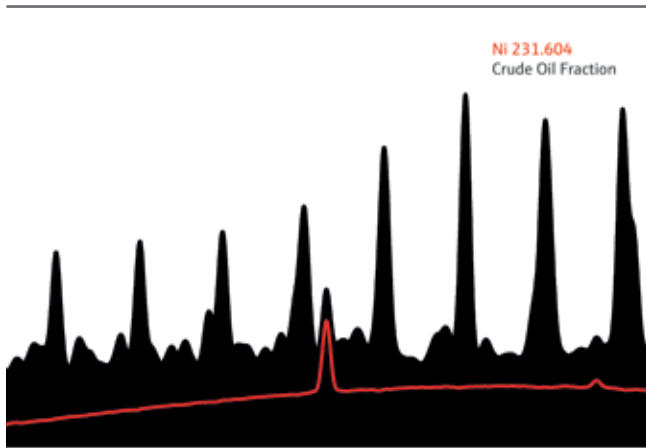

PlasmaQuant® PQ 9000 Elite – the Number One in spectral resolution and sensitivity!

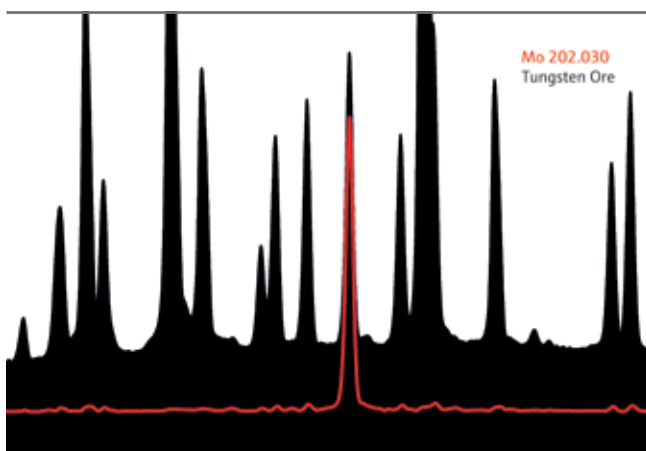

Resolving spectral interferences the most sensitive emission lines of trace elements can be used in almost any sample!

PlasmaQuant® PQ 9000

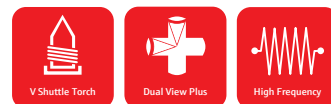

Convincing All-rounder

With a clear emphasis on wide applicability, simplicity and cost effectiveness in general applications the PlasmaQuant® PQ 9000 is not just another ICP-OES. It's the one for those who need more!

More Matrix Tolerance

Engineered for unrivalled matrix tolerance, its **High-Frequency Generator** boosts the method robustness of environmental, polymer or geological routines. Contributing to a stark reduction in sample handling and warm-up time PlasmaQuant® PQ 9000 eases shift-operation benefiting your productivity.

More Ease of Use

Even in matrix-rich samples like soils, petrochemicals, galvanic or saline waste waters, deposit-free performance becomes state-of-the-art thanks to the vertical plasma of the **V Shuttle Torch**. Torch installation and maintenance is cut short to an easy plug-and-play routine without connecting tubing/gases and no manual torch alignment.

More Working Range

Synchronous analysis of traces elements and major constituents essential to agriculture and food samples is made possible by the **Dual View PLUS** featuring 2+2 plasma views. Avoiding sample preparation and repetitive measurements, a linear working range from low ppb to high weight percent adds to the terrific operator convenience.

The argon-neutral counter-gas-technology of the PlasmaQuant® PQ 9000 ensures excellent sensitivity for more than 43,000 emission lines in the range from 160 to 900 nm. Spectral resolution of less than 6 pm at 200 nm fulfills the demands of general ICP-OES applications with uncompromised accuracy.

PlasmaQuant® PQ 9000 – providing quality results in contract analysis, reliability in quality control and highest standards in regulated industries!



Software Solutions

Analytical software should be made for anything and anyone. It must satisfy requirements of most diverse application fields. It has to be simple above all; and compliant with regulations.

The ASpect PQ software package operates, monitors and documents all processes of the PlasmaQuant® PQ 9000 series and its accessories. Its modular design offers both highest operator flexibility for highly customized analytics as well as the convenience of pre-set method templates that are easy to operate and modify. Online status updates on smart phones, tablets etc. increase the productivity of unattended operations.

Pick and Click

Getting started on your samples is as easy as it gets! Thanks to the clearly laid-out, multilingual user interface methods are quickly generated. Just 'pick-and-click' your elements, your matrix and your favorite lines. Pre-installed method parameters will load automatically and allow starting in no time.

Interactive software applets offering comprehensive information (e.g. BEC values, interferences, stock standards, correction models, sample IDs etc.) and assistance for operators of any skill and training help you getting accurate results at the first try.

Clever Reporting Tools

Practical **reporting tools** e.g. for 100 % normalization of elemental and oxide contents as well as screening methods for fast **overview analytics** of unknown samples with integrated calibration curves are ready to use.

LIMS connectivity and an **FDA module** with advanced user management strengthen the applicability of the PlasmaQuant® PQ 9000 series. Compliance with ICP-OES regulations of all industries and **21 CFR Part 11** is guaranteed.

Self-Check System

Online checking of all instrument parameters in real time – including nebulizer blockage and plasma stability to protect glassware – automatic alerts, emergency shut-down and online help facilities ensure safe operation, low maintenance and costs.

Easy as ABC

Among the many powerful optimization, evaluation and reprocessing tools, the unprecedented **automatic baseline correction algorithm ABC** really stands out. Automatically fitting a global baseline to the entire spectral background precision, method robustness and detection limits improve substantially. In view of the immense reduction of data handling, the ABC, increases ease of use and productivity. Operator approximations and guess work becomes a relic of the past. Today, baseline fitting is as easy as ABC!

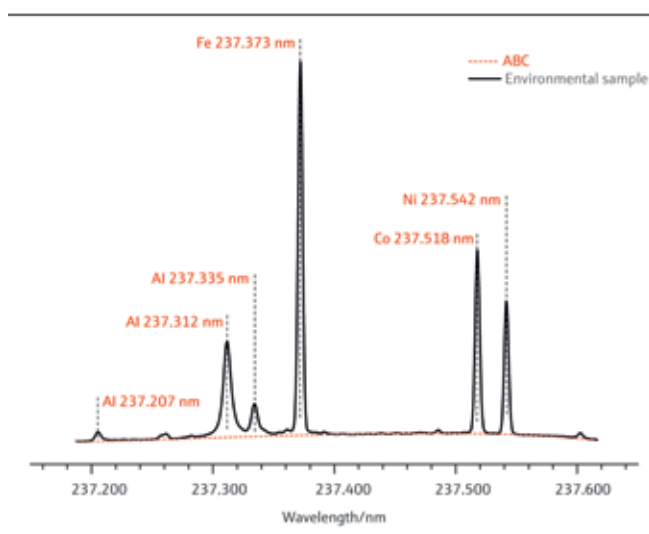

Automatically fitting a baseline to any spectrum the ABC is a revelation in data evaluation.

Reveal the Detail

A convenient tool for the analysis of materials infamous for their wealth of emission lines and complex interferences, the **CSI**-software tool allows for the **correction of spectral interferences** even in the most challenging matrices.

CSI utilizes a sophisticated least-square algorithm to subtract one or more unsmoothed correction spectra in real time or during reprocessing. It is the most powerful correction tool on the market as it increases the accuracy, detection limits and method robustness as well as the productivity of your analytics.

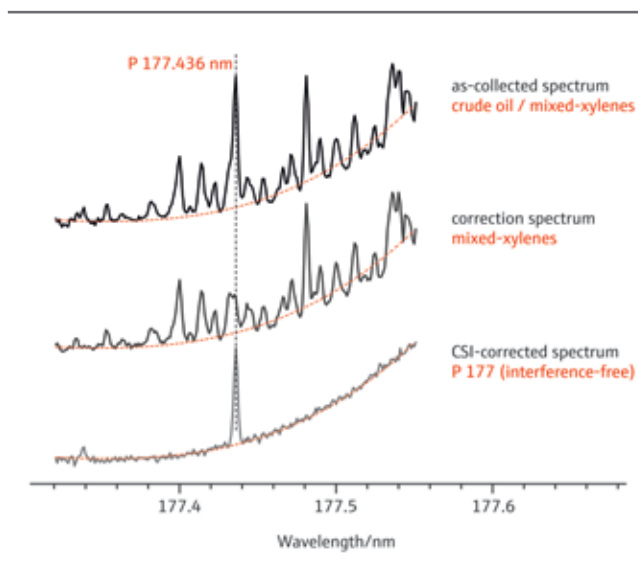

Being the most powerful correction tool on the market CSI sets a new standard in interference removal.

Analytik Jena – the technology leader in spectrometry

Optical Spectrometry



novAA® series

Classical line source AAS with Dual Optics and Deuterium background correction.

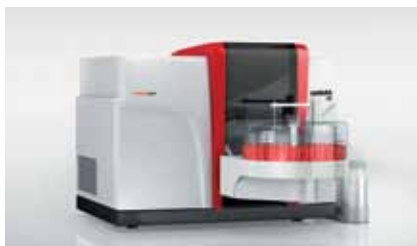

contrAA® series

High-Resolution Continuum Source AAS with simultaneous background correction for fast sequential and simultaneous multi-element analysis.



ZEEnit® series

Line source AAS with Deuterium and Zeeman background correction with third generation magnetic field control.



PlasmaQuant® PQ 9000 series

High-Resolution Array ICP-OES with Dual View PLUS views of a vertical plasma providing unique robustness and sensitivity.

Mass Spectrometry



PlasmaQuant® MS series

Bench-top ICP-MS with patented ion optics for unmatched sensitivity and robust plasma performance with only half the argon gas.

Sample Preparation



TOPwave®

Microwave digestion system with contactless pressure and temperature monitoring for all samples.

Headquarters

Analytik Jena AG
Konrad-Zuse-Str. 1
07745 Jena · Germany

Phone +49 3641 77 70
Fax +49 3641 77 9279
info@analytik-jena.com
www.analytik-jena.com

Pictures: Analytik Jena AG, p. 8: iStockphoto®/sdlgzps, iStockphoto®/SunDevilStormin
Subjects to changes in design and scope of delivery as well as further technical development!